



Commercial & Residential Site Amenities

Commercial Lighting

LED Acorn Lighting

Decorative Signage Poles

Traffic Regulatory Signage

Entrance / Wayfinding Signage

Bollards

Curbside Mailboxes

Decorative Mailbox Posts

Cluster Box Units

Address Plaques

and much more



Custom Home Accessories, Inc.
1-800-265-0041
www.customhomex.com



This new Site Amenities catalog is focused for the commercial and residential Developer, Builders and Home Owners Associations.

Whether you have been purchasing from us since the sixties or are contemplating ordering for the first time, our commitment to you will always remain the same: a quality product, an excellent value, and outstanding customer service. Your complete satisfaction is our only goal.



TABLE OF CONTENTS

■ COMMERCIAL LIGHTING

- Commercial Light Fixtures	4 - 7
- LED Lighting	8 - 9
- LED Dark Sky Bulb	10
- LED & HID Acorn Lighting	11
- HPS & MH Dark Sky Reflector	12
- Sphere Lighting	13
- Commercial Lighting Accessories	15
- Lighting Poles & Accessories	16 - 17
- Tri-Light Fixtures	18
- Decorative Lighting / HID Ballasts	19

■ 4" O/D ROUND SIGNAGE POLES / SITE ACCESSORIES / WAYFINDING SIGNS

- 4" Traffic Poles	20 - 25
- How To Order	26 - 29
- Bollards	30
- Decorative Parking Meter Kit	30
- Breakaway Poles	31
- Wayfinding & Entrance Signs	32 - 35

■ 3" O/D ROUND & 4" SQUARE SIGNAGE POLE SERIES

- Vista Series	38 - 41
- Classic Series	42 - 45
- Town Square Series	46 - 49
- Main Street Series	50 - 51
- How To Order	52 - 55

■ RESIDENTIAL & COMMERCIAL MAILBOXES

- Curbside Mailbox Units	56 - 57
- Gangbox Units	58
- Curbside Mailbox Accessories	59
- Address Plaques	60
- Cluster Box Units	61

■ FINISH OPTIONS

- Solid & Antique Finish Options	62
----------------------------------	----



- **SMB1-12**
(Surface Mount Base with a 3" Fluted Pole)
- **SMB-J12** (Anchor Bolts)
- **SHD1-AC1026CL-Type V**
(Fixture & Prismatic Globe)
- **PFIN** (Finial)

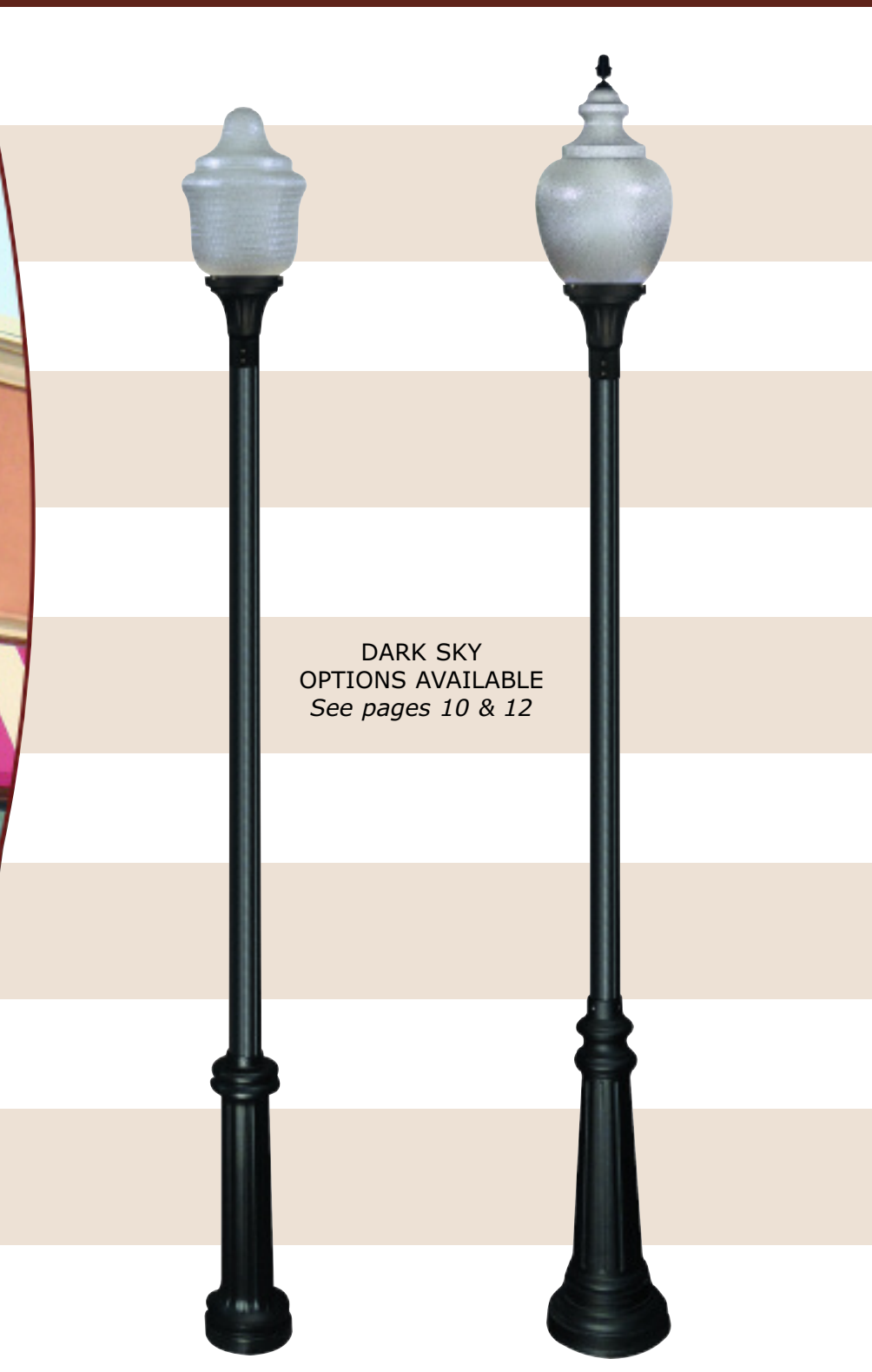

DARK SKY
OPTIONS AVAILABLE
See pages 10 & 12

- **MP-414**
(3" Fluted Direct Burial Pole)
- **SHD1-PC2020CL**
(Fixture & Globe)
- **WRB1** (Wrap Around Base)

- **SMB1-12**
(Surface Mount Base with a 3" Fluted Pole)
- **SMB-J12** (Anchor Bolts)
- **SHD1-PC1023CL**
(Fixture & Globe)
- **PFIN** (Finial)

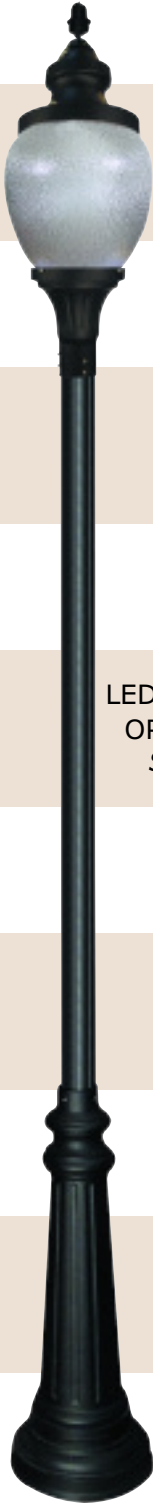

LED and HID LIGHTING
 OPTIONS AVAILABLE
 See pages 8 - 13

*Poles available in:
 8 ft., 10 ft., 12 ft.,
 14 ft., and 16 ft.
 lengths.*

*Poles also available
 with Access Door.
 See page 17 for details*

- **MP-414**
 (3" Fluted Direct Burial Pole)
- **SHD2-PC3018WH**
 (Fixture & Globe)
- **WRB1** (Wrap Around Base)

- **SMB1-12**
 (Surface Mount Base with
 a 3" Fluted Pole)
- **SMB-J12** (Anchor Bolts)
- **SHD1-PC1023CL**
 (Fixture & Globe)
- **SR** (Solid Roof)
- **PFIN** (Finial)

- **MP-414**
 (3" Fluted Direct Burial Pole)
- **SHD1-PC1023CL**
 (Fixture & Globe)
- **PFIN** (Finial)
- **TSB-201-1824**
 (18" X 24" Sign Frame)
- **18" x 24" Custom Sign**
- **WRB1** (Wrap Around Base)

- **MP-414**
 (3" Fluted Direct Burial Pole)
- **SHD1-AC1026CL-Type III**
 (Fixture & Prismatic Globe)
- **WRB6** (Wrap Around Base)



- **SMB2-12**
(Surface Mount Base with a 3" Fluted Pole)
- **SMB-J12** (Anchor Bolts)
- **SHD1-PC1023CL**
(Fixture & Globe)
- **SR** (Solid Roof)
- **PFIN** (Finial)

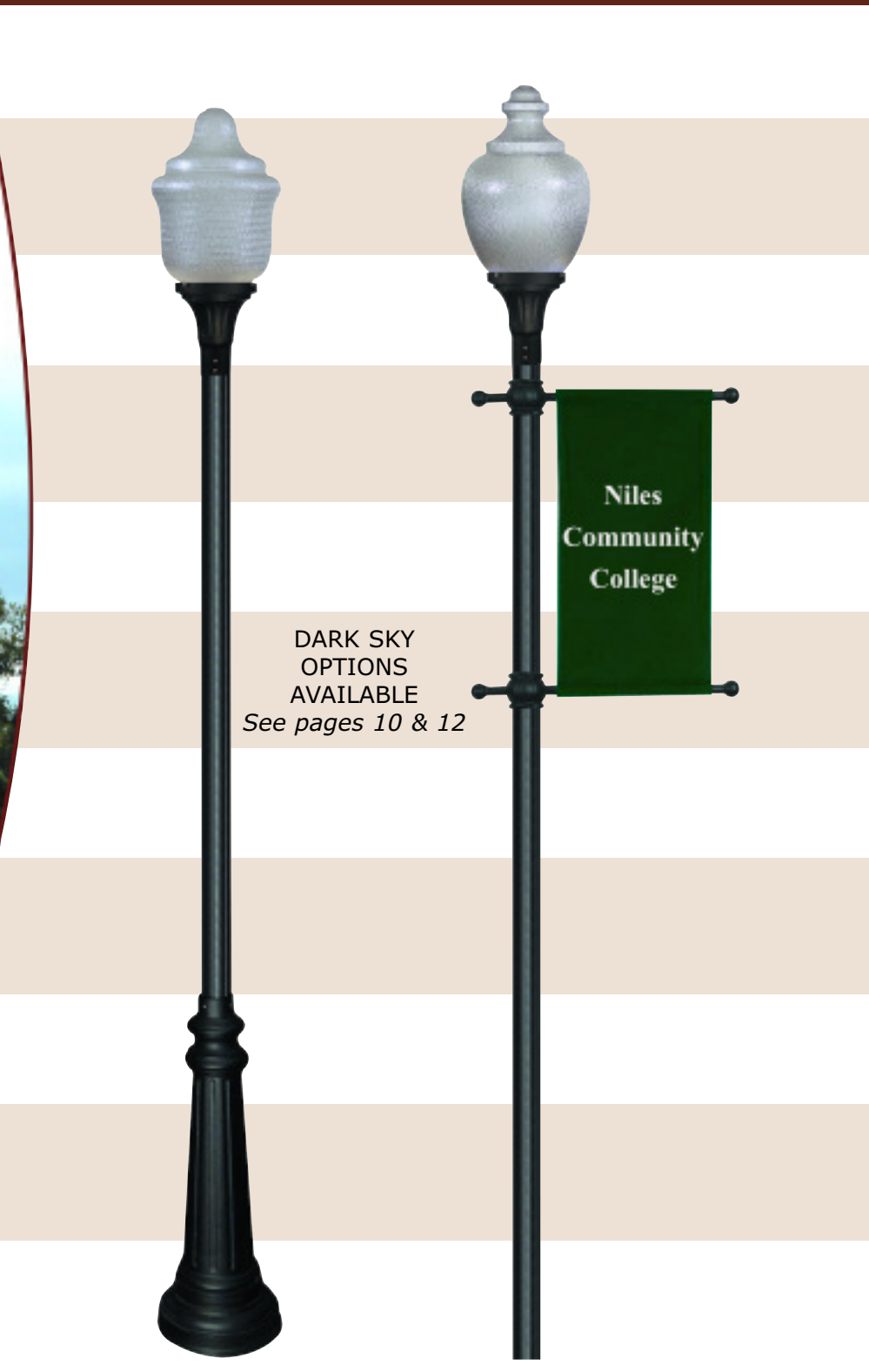

DARK SKY
OPTIONS
AVAILABLE
See pages 10 & 12

- **SMB1-12**
(Surface Mount Base with a 3" Fluted Pole)
- **SMB-J12** (Anchor Bolts)
- **SHD1-PC2020CL**
(Fixture & Globe)

- **MP-414**
(3" Fluted Direct Burial Pole)
- **SHD1-PC1023CL**
(Fixture & Globe)
- **TSB-206-Banner Arms x 2**
(Decorative Banner Arms)

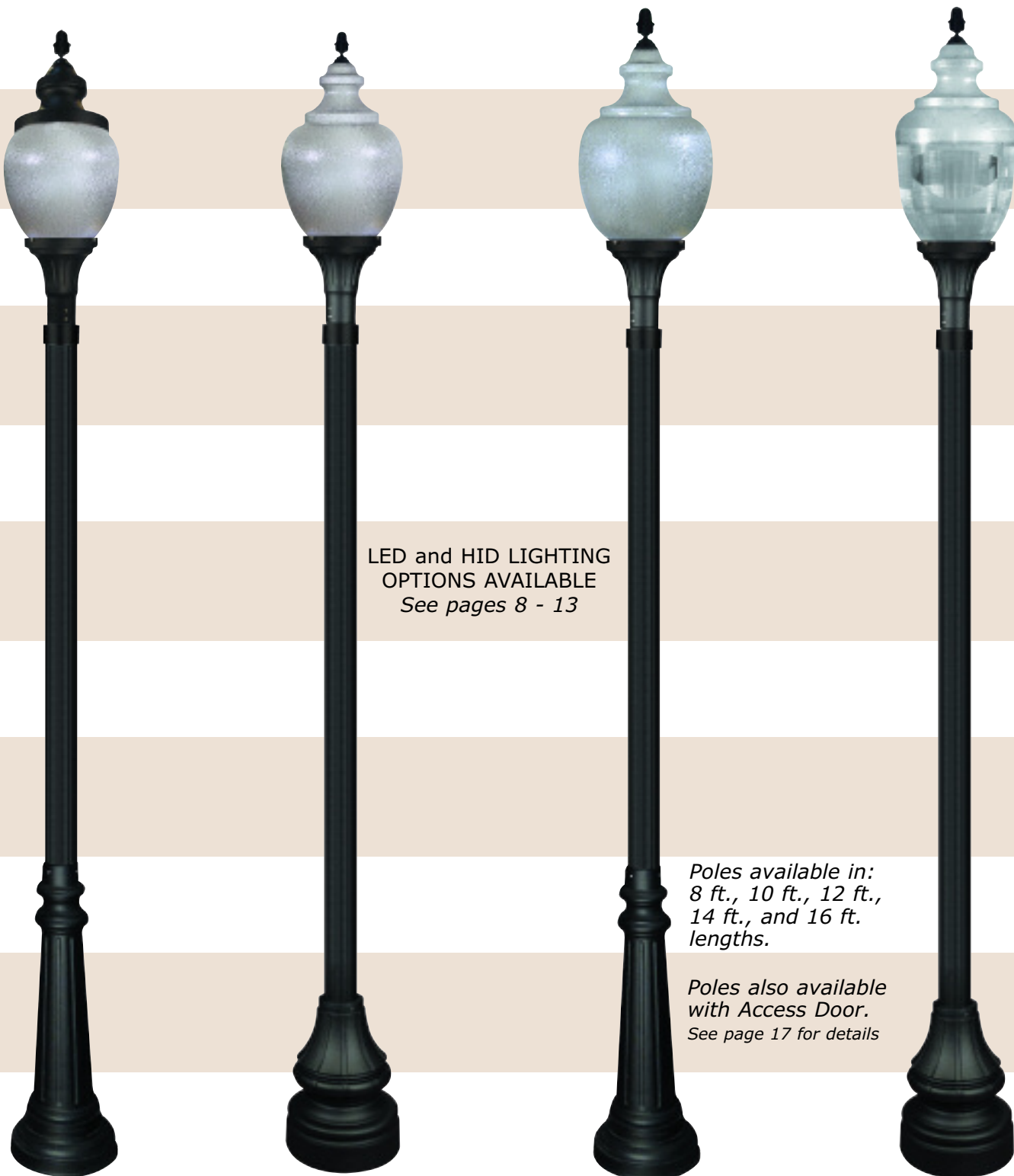

LED and HID LIGHTING
 OPTIONS AVAILABLE
 See pages 8 - 13

*Poles available in:
 8 ft., 10 ft., 12 ft.,
 14 ft., and 16 ft.
 lengths.*

*Poles also available
 with Access Door.
 See page 17 for details*

- **MP-614**
 (4" Fluted Direct Burial Pole)
- **SHD1-PC1023CL**
 (Fixture & Globe)
- **SR** (Solid Roof)
- **PFIN** (Finial)
- **TSB-15** (4" - 3" Pole Adapter)
- **WRB9** (Wrap Around Base)

- **MP-614**
 (4" Fluted Direct Burial Pole)
- **SHD1-PC1023CL**
 (Fixture & Globe)
- **PFIN** (Finial)
- **TSB-15** (4" - 3" Pole Adapter)
- **WRB11** (Wrap Around Base)

- **MP-614**
 (4" Fluted Direct Burial Pole)
- **SHD1-PC1026CL**
 (Fixture & Globe)
- **PFIN** (Finial)
- **TSB-15** (4" - 3" Pole Adapter)
- **WRB9** (Wrap Around Base)

- **MP-614**
 (4" Fluted Direct Burial Pole)
- **SHD1-AC1026CL-Type III**
 (Fixture & Prismatic Globe)
- **PFIN** (Finial)
- **TSB-15** (4" - 3" Pole Adapter)
- **WRB11** (Wrap Around Base)

LED LIGHTING



Cities all over the world are converting streetlights to low-energy Light Emitting Diode (LED) fixtures, and for good reason. LEDs offer the highest energy savings of any lighting source available.

In addition to energy savings and longer life, LEDs have other advantages.

- LED is the greenest light source available because of their tremendous energy savings and the fact that they contain no hazardous materials, such as mercury.
- LED lights do not attract bugs because they do not produce UV light. UV light is the reason that bugs are drawn to traditional light sources.
- Also, because LEDs emit directional light, we have more control over what is illuminated (streets and sidewalks) and what is not (the night sky).

Special Lite Products provides you with the option to retro-fit your existing fixture with our standard LED or Dark Sky Complaint LED bulbs. **Retro-fits of conventional streetlights pay for themselves in three to seven years.**

(See page 9 - 10 for bulb options.)

We also provide complete LED fixture options.

(See page 11 for lighting fixture options)

LED BULBS:

- Have greater than 50,000 hours life span
- Double the life span of Metal Halide and High Pressure Sodium bulbs
- Five year warranty
- Also available in Dark-Sky Compliant version
(see page 10 for dark sky bulb details)

HID to LED Replacement chart

Numbers are approximate

Metal Halide Wattage	High Pressure Sodium Wattage	LED Wattage
50 Watt	50 Watt	•
70 Watt	70 Watt	20 Watt
100 Watt	100 Watt	•
150 Watt	150 Watt	24 Watt
200 Watt	200 Watt	30 Watt
250 Watt	250 Watt	36 Watt



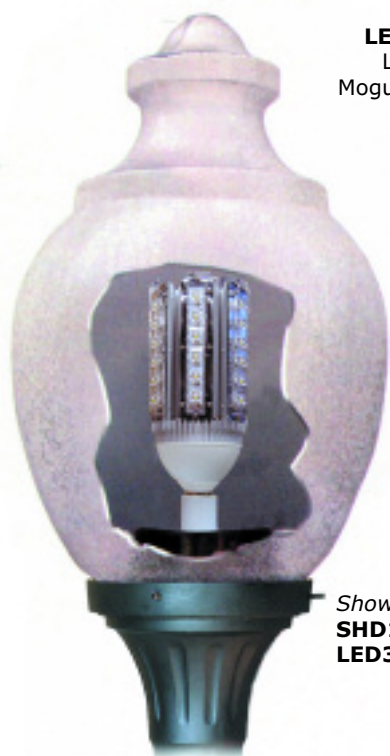

Item #
LED-30-MOG
LED Exterior
Mogul Base Bulb



Shown:
SHD1-PC1023CL /
LED30MOG

Available LED Bulbs:

MEDIUM BASE

<i>Item #</i>	<i>Wattage</i>
LED20MED	20 Watt Bulb
LED24MED	24 Watt Bulb
LED30MED	30 Watt Bulb

MOGUL BASE

<i>Item #</i>	<i>Wattage</i>
LED20MOG	20 Watt Bulb
LED24MOG	24 Watt Bulb
LED30MOG	30 Watt Bulb
LED36MOG	36 Watt Bulb

LED Bulb Specs:

INPUT VOLTAGE	110 - 240V
POWER FACTOR	> .99
BASE	Medium / Mogul
TOTAL LUMENS	2,000 - 8,000 lm
LUMINOUS FLUX	110 lm/w
DIMENSIONS	3.9" x 10"
CERTIFICATE	CE, RoHS, UL
COLOR TEMPERATURE	3000 -7000k
WORKING TEMPERATURE	-35° C to 45° C
IP RATING	IP65

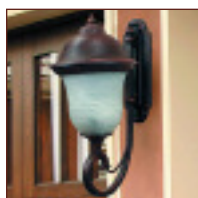

LED DARK SKY COMPLIANT BULB

Our LED Dark Sky outdoor bulb puts light only where it is needed reducing energy use and saving you money. It also reduces the negative effects of light pollution on the environment.

Dark Sky outdoor lighting reduces glare, dramatically improves security and night time visibility.

- Greater than 50,000 hours life span
- Double the life span of Metal Halide and High Pressure Sodium bulbs
- Five year warranty

Item # LED30MOG-DS
30 watt Mogul Base
Dark Sky L.E.D. Bulb

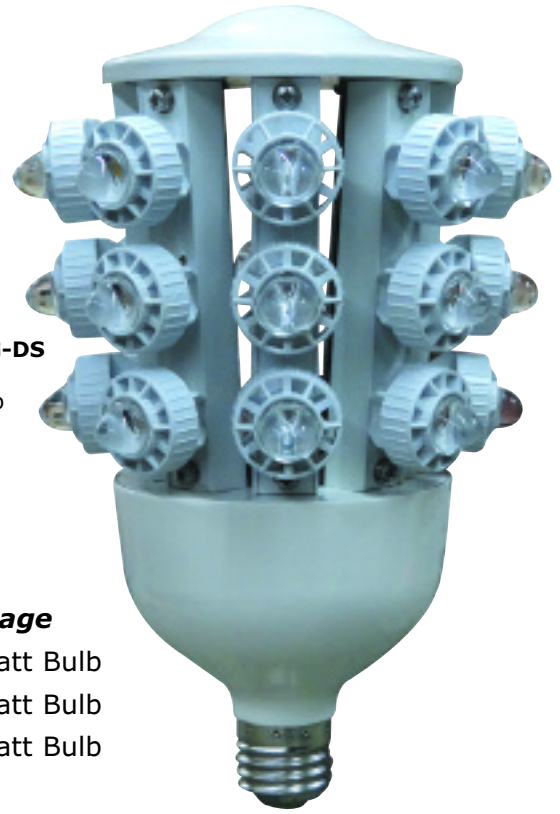

Available LED Bulbs:

MEDIUM BASE

Item #	Wattage
LED20MOG-DS	20 Watt Bulb
LED30MED-DS	30 Watt Bulb
LED45MED-DS	45 Watt Bulb

MOGUL BASE

Item #	Wattage
LED20MOG-DS	20 Watt Bulb
LED30MOG-DS	30 Watt Bulb
LED45MOG-DS	45 Watt Bulb

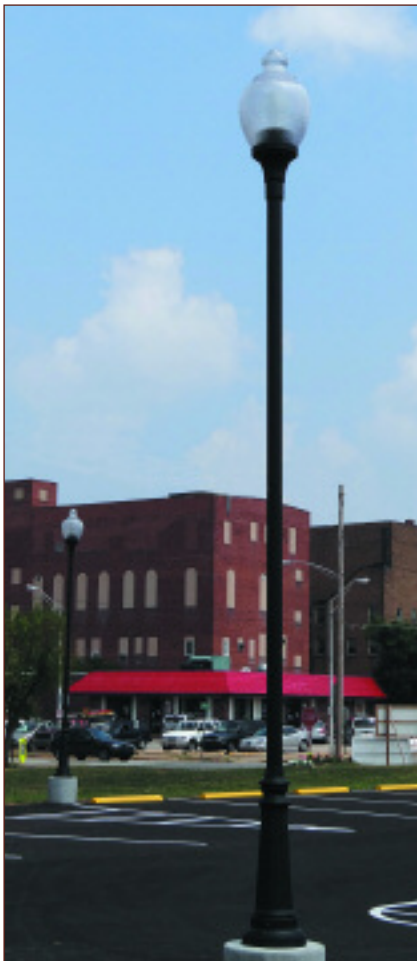

LED Dark Sky Bulb Specs:

INPUT VOLTAGE	110 - 277V
WATTAGE	20w, 30w, 45w
TOTAL LUMENS	3250 lm
LUMINOUS FLUX	110 lm/w
CERTIFICATE	ETL, CSA C22.2, RoHS, UL
COLOR TEMPERATURE	4500 - 5000k
WORKING TEMPERATURE	-20° C to 40° C
IP RATING	IP65

LED bulbs can be used in many of Special Lite's commercial and residential light fixtures. Call for details.



LED & HID ACORN LIGHTING

We offer a complete selection of polycarbonate acorn globe fixtures in **LED, High Pressure Sodium, Metal Halide** and **Incandescent** light sources. These quality lighting fixtures are manufactured from Cast Aluminum with enclosed ballast and stainless steel hardware. Porcelain sockets will be Medium or Mogul base. TSB-15 (4" to 3" Pole Adapter) required if using with a 4" O/D pole (*sold separately*).

LED

- Energy Efficient
- 50,000 + hours life span

Metal Halide

- Produces a pure white light
- Bulbs last six times longer than incandescent

High Pressure Sodium

- Produces a golden-pink cast
- Bulbs rated at 24,000 hours

Item #
2810-PC1016CL

Incandescent (INCAN.) Acorn Light 16" Polycarbonate Globe

Model #	Description	Voltage	Socket	Bulb Included
2810-PC1016CL-INCAN	300 WATT INCAN.	120	MEDIUM	NO
2817-PC1016CL-INCAN	300 WATT INCAN.	120	MEDIUM	NO

LED Acorn Light 16" Polycarbonate Globe

Model #	Description	Voltage	Socket	Bulb Included
2810-PC1016CL-LED20MOG	20 WATT LED	120	MOGUL	YES
2810-PC1016CL-LED24MOG	24 WATT LED	120	MOGUL	YES
2810-PC1016CL-LED30MOG	30 WATT LED	120	MOGUL	YES
2810-PC1016CL-LED36MOG	36 WATT LED	120	MOGUL	YES
2817-PC1016CL-LED20MOG	20 WATT LED	120	MOGUL	YES
2817-PC1016CL-LED24MOG	24 WATT LED	120	MOGUL	YES
2817-PC1016CL-LED30MOG	30 WATT LED	120	MOGUL	YES
2817-PC1016CL-LED36MOG	36 WATT LED	120	MOGUL	YES

Item #
SHD1-PC1023CL

Fitter-3" Tenon

High Pressure Sodium (HPS) Acorn Light 23" Polycarbonate Globe

Model #	Description	Voltage	Socket	Bulb Included
SHD1-PC1023CL-INCAN	300 WATT INCAN.	120	MEDIUM	NO
SHD1-PC1023CL-70HPS	70 WATT HPS	120-208-240-277	MEDIUM	NO
SHD1-PC1023CL-100HPS	100 WATT HPS	120-208-240-277	MEDIUM	NO
SHD1-PC1023CL-150HPS	150 WATT HPS	120-208-240-277	MOGUL	NO

Metal Halide (MH) Acorn Light 23" Polycarbonate Globe

Model #	Description	Voltage	Socket	Bulb Included
SHD1-PC1023CL-70MH	70 WATT MH	120-208-240-277	MEDIUM	NO
SHD1-PC1023CL-100MH	100 WATT MH	120-208-240-277	MEDIUM	NO

LED Acorn Light 23" Polycarbonate Globe

Model #	Description	Voltage	Socket	Bulb Included
SHD1-PC1023CL-LED20MOG	20 WATT LED	120	MOGUL	YES
SHD1-PC1023CL-LED24MOG	24 WATT LED	120	MOGUL	YES
SHD1-PC1023CL-LED30MOG	30 WATT LED	120	MOGUL	YES
SHD1-PC1023CL-LED36MOG	36 WATT LED	120	MOGUL	YES

Item #
SHD1-PC1026CL

Fitter-3" Tenon

High Pressure Sodium (HPS) Acorn Light 26" Polycarbonate Globe

Model #	Description	Voltage	Socket	Bulb Included
SHD1-PC1026CL-INCAN	300 WATT INCAN.	120	MEDIUM	NO
SHD1-PC1026CL-70HPS	70 WATT HPS	120-208-240-277	MEDIUM	NO
SHD1-PC1026CL-100HPS	100 WATT HPS	120-208-240-277	MEDIUM	NO
SHD1-PC1026CL-150HPS	150 WATT HPS	120-208-240-277	MEDIUM	NO

Metal Halide (MH) Acorn Light 26" Polycarbonate Globe

Model #	Description	Voltage	Socket	Bulb Included
SHD1-PC1026CL-70MH	70 WATT MH	120-208-240-277	MEDIUM	NO
SHD1-PC1026CL-100MH	100 WATT MH	120-208-240-277	MEDIUM	NO
SHD1-PC1026CL-150MH	150 WATT MH	120-208-240-277	MEDIUM	NO

LED Acorn Light 26" Polycarbonate Globe

Model #	Description	Voltage	Socket	Bulb Included
SHD1-PC1026CL-LED20MOG	20 WATT LED	120	MOGUL	YES
SHD1-PC1026CL-LED24MOG	24 WATT LED	120	MOGUL	YES
SHD1-PC1026CL-LED30MOG	30 WATT LED	120	MOGUL	YES
SHD1-PC1026CL-LED36MOG	36 WATT LED	120	MOGUL	YES

Item #
SHD3-PC1026CL

Fitter-3" Tenon

250 Watt Acorn Light 26" Polycarbonate Globe

Model #	Description	Voltage	Socket	Bulb Included
SHD3-PC1026CL-250HPS	250 WATT HPS	120-208-240-277	MOGUL	NO
SHD3-PC1026CL-250MH	250 WATT MH	120-208-240-277	MOGUL	NO

DARK SKY REFLECTOR

For High Pressure Sodium
and Metal Halide Ballasts

This product meets new IES criteria for Uplight minimization. The amount of "Cut Off" you require can be achieved through the proper positioning of this component. With three standard mounting heights and unlimited possibilities, you can achieve maximum usable light while still allowing only a minimal amount of Uplight. Use with most Traditional Streetlamps, Globes & Acorns (for neck size 8" or larger, 7" min opening.)

- High Downlight Efficiency
- Low Uplight Levels
- Ideal For Retrofits
- Easy To Install, Self Collapsing Design

- Easy Access for Lamp Replacement
- Made of High Heat Resin
- Self Positioning & Leveling
- Adjustable Light Output Levels
- **Use with 150W MH Max (237°F / 114°C)**

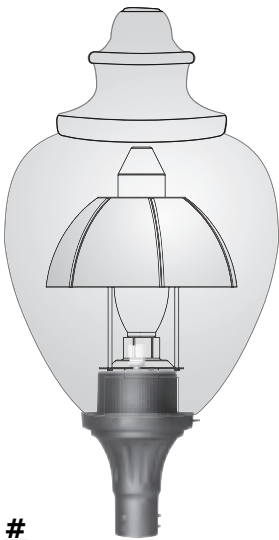

Item #
DSR-360-MED
(fits over medium base socket)
DSR-360-MOG
(fits over mogul base socket)

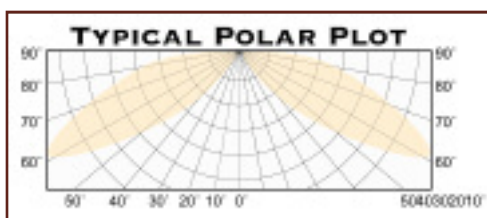
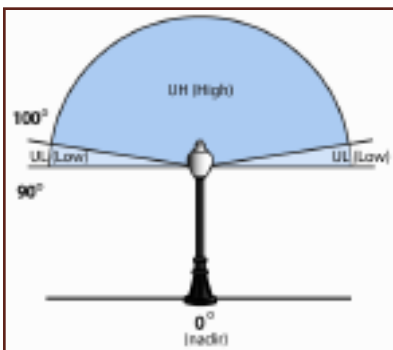

	Dark Sky Reflector
FORWARD LIGHT	
LUMINAIRE LUMENS	4493.7
%LAMP LUMENS	29.96%
FL (0°-30°)	0.95%
FM (30°-60°)	9.91%
FH (60°-80°)	15.70%
FVH (80°-90°)	3.41%
BACK LIGHT	
LUMINAIRE LUMENS	4493.7
%LAMP LUMENS	29.96%
BL (0°-30°)	0.95%
BM (30°-60°)	9.91%
BH (60°-80°)	15.70%
BVH (80°-90°)	3.41%
UPLIGHT	
LUMINAIRE LUMENS	5140.8
%LAMP LUMENS	6.44%
UL (90°-100°)	2.28%
BVH (100°-180°)	4.16%
TRAPPED LIGHT	
LUMINAIRE LUMENS	5046.0
%LAMP LUMENS	33.64%
TOTAL LIGHT EFFICIENCY	66.3%
DOWNWARD LIGHT EFFICIENCY	60.0%
UPWARD LIGHT LOW (UL)	2.28%
UPWARD LIGHT HIGH (UH)	4.16%
MAX CANDLEPOWER ZONE	62.5°

CAUTION: Product should not be exposed to temperatures exceeding 237°F / 114°C (MAX Lamp 150W Metal Halide).

SPHERE LIGHTING

Cast Aluminum fixture with enclosed ballast and stainless steel hardware. Ballast can be easily changed in the field by loosening two screws. Porcelain socket will be Medium base. Spherical Replacement Globes are available in White Finish. Lamp not included. TSB-15 (4" to 3" Pole Adapter) required if using with a 4" O/D pole (*sold separately*).

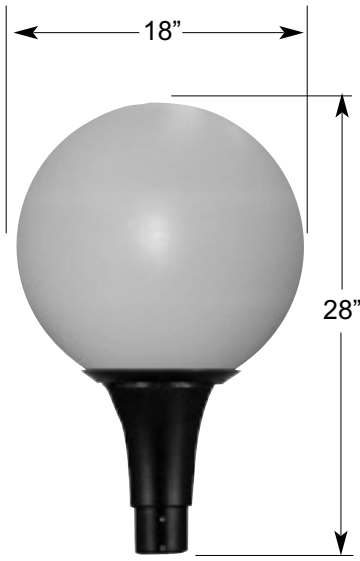

Item #
SHD2-PC3018WH
Globe available in
White finish.

Fitter-3" Tenon

High Pressure Sodium Sphere (HPS) Light - 16" White Polycarbonate Globe					
Model #	Description	Voltage	Socket	Bulb Included	
SHD2-PC3016WH-INCAN	300 WATT INCAN.	120	MEDIUM	NO	
SHD2-PC3016WH-50HPS	50 WATT HPS	120-277	MEDIUM	NO	
SHD2-PC3016WH-70HPS	70 WATT HPS	120-208-240-277	MEDIUM	NO	
SHD2-PC3016WH-100HPS	100 WATT HPS	120-208-240-277	MEDIUM	NO	
SHD2-PC3016WH-150HPS	150 WATT HPS	120-208-240-277	MEDIUM	NO	

Metal Halide Sphere (MH) Light - 16" White Polycarbonate Globe					
Model #	Description	Voltage	Socket	Bulb Included	
SHD2-PC3016WH-50MH	50 WATT MH	120-277	MEDIUM	NO	
SHD2-PC3016WH-70MH	70 WATT MH	120-208-240-277	MEDIUM	NO	
SHD2-PC3016WH-100MH	100 WATT MH	120-208-240-277	MEDIUM	NO	

High Pressure Sodium (HPS) Sphere Light - 18" White Polycarbonate Globe					
Model #	Description	Voltage	Socket	Bulb Included	
SHD2-PC3018WH-INCAN	300 WATT INCAN	120	MEDIUM	NO	
SHD2-PC3018WH-50HPS	50 WATT HPS	120-277	MEDIUM	NO	
SHD2-PC3018WH-70HPS	70 WATT HPS	120-208-240-277	MEDIUM	NO	
SHD2-PC3018WH-100HPS	100 WATT HPS	120-208-240-277	MEDIUM	NO	
SHD2-PC3018WH-150HPS	150 WATT HPS	120-208-240-277	MEDIUM	NO	

Metal Halide (MH) Sphere Light - 18" White Polycarbonate Globe					
Model #	Description	Voltage	Socket	Bulb Included	
SHD2-PC3018WH-50MH	50 WATT MH	120-277	MEDIUM	NO	
SHD2-PC3018WH-70MH	70 WATT MH	120-208-240-277	MEDIUM	NO	
SHD2-PC3018WH-100MH	100 WATT MH	120-208-240-277	MEDIUM	NO	

110 VOLT SPHERE LIGHTING - 3" Standard Cast Aluminum Fitters with Medium Base Sockets

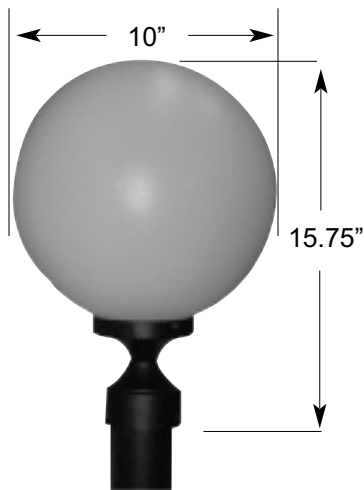

Item #
2790-AC3010 (shown)

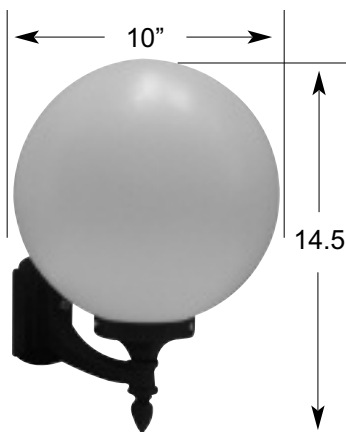

Item #
2797-AC3010 (shown)

White Acrylic Sphere Lites (available in 10" and 12" Dia.)

Acrylic globes possess low impact strength, medium heat resistance and offers good weatherability when exposed to UV.

- Medium Base Socket Standard.
- Maximum Wattage is 100 Watts
- Incandescent
- Not available in H.I.D.

Available Products:

2790-AC3010	Post Mount 10" Globe
2790-AC3012	Post Mount 12" Globe
2797-AC3010	Wall Mount 10" Globe
2797-AC3012	Wall Mount 12" Globe

REPLACEMENT GLOBES

POLYCARBONATE GLOBES

We supply a complete line of replacement O.E.M. street light globes. Traditional acorn globes are available in textured clear and Sphere globes are offered in white.

PC1016CL - Clear Globe

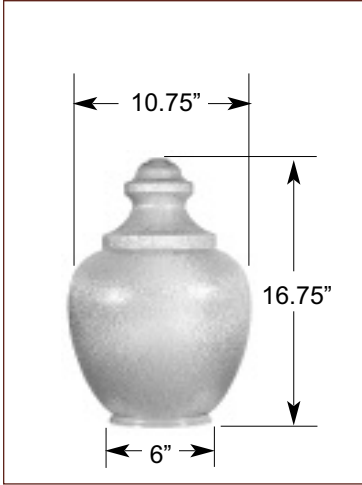

PC1023CL - Clear Globe

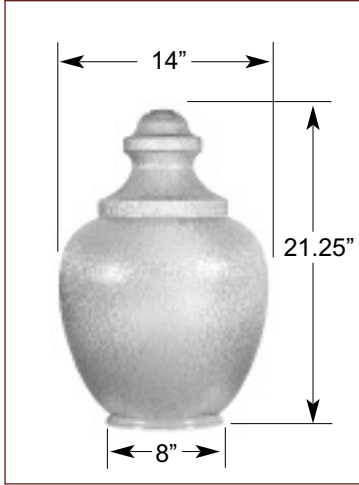

PC1026CL - Clear Globe

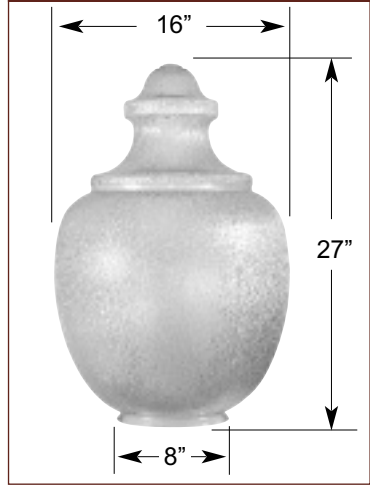

PC2020CL - Clear Globe

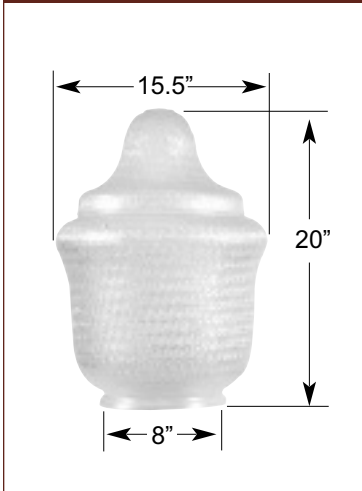

PC3016WH - White Globe

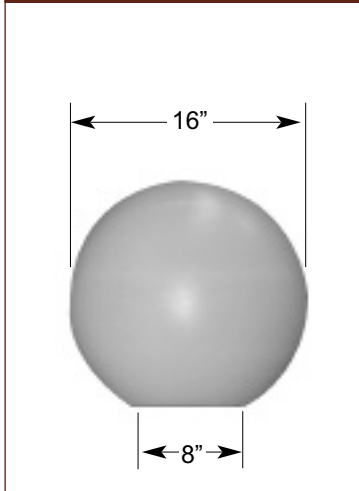

PC3018WH - White Globe

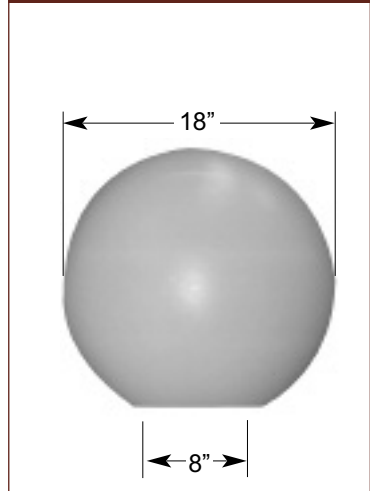

ACRYLIC GLOBES

AC1026CL-Type III

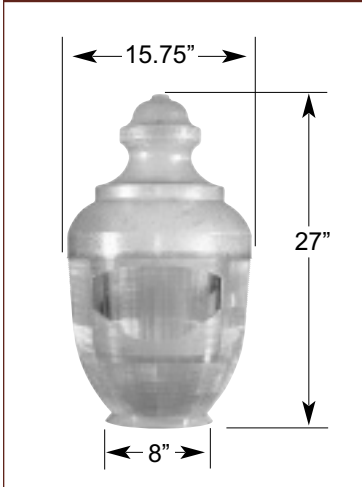

AC1026CL-Type V

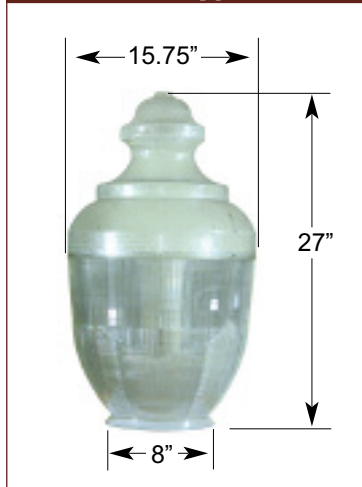

We offer a complete line of today's state of the art Acrylic Prismatic globes with the latest internal reflector technology. Our prismatic globes are available in two different light distribution patterns.

OPTICS



Type III Distribution



Type V Distribution

COMMERCIAL LIGHTING ACCESSORIES

HOUSE SHIELDS / DARK SKY REFLECTOR

House side shields are available to cutoff all direct light through certain horizontal angles. Both models clamp around the socket and are designed to be positioned in the field after installation of the fixture.

Item

HSS-180 (180 degree cutoff)

8.5" H x 6 7/8" W

HSS-90 (90 degree cutoff)

7 15/16" H x 4 5/8" W

Dark Sky Reflector (see page 12 for details)

DSR-360-MED or **DSR-360-MOG**

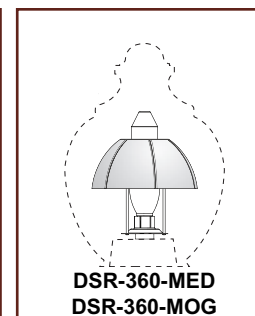
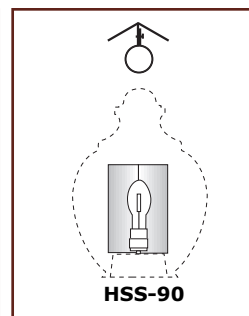
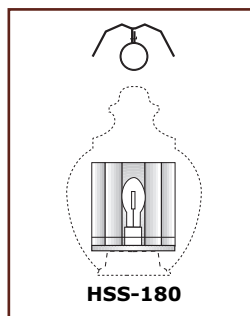

LAMP ARMS

Wall mount and post mount commercial lamp arms can accommodate any of our available commercial light fitters and globes. The cross arm design features a strong yet lightweight design for ease of installation.

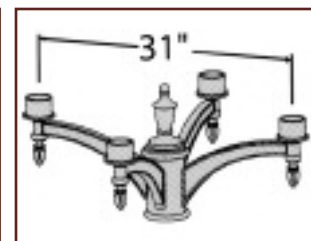
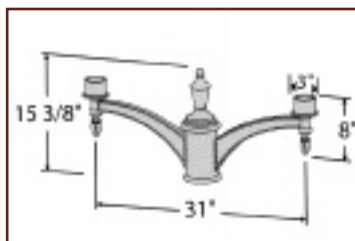
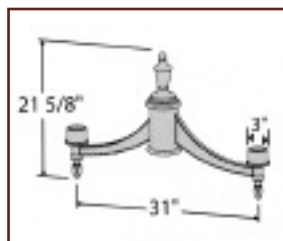
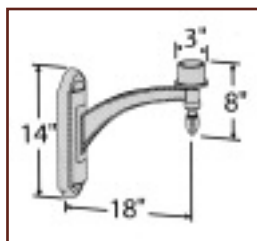
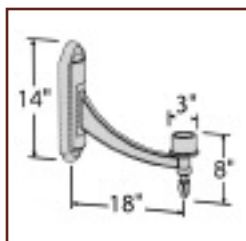

ADDITIONAL ACCESSORIES

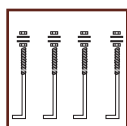
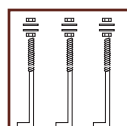
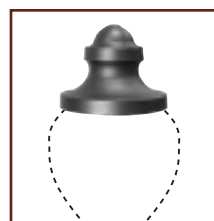

Item # **SPB-190**
For use with 3" O/D poles
Item # **SPB-690**
For use with 4" O/D poles

LIGHTING POLES & ACCESSORIES

Our lighting poles and accessories are made of Extruded Aluminum and Cast Aluminum and are available in your choice of 14 durable powder coated base finishes. Direct burial poles require a minimum of 18" of the pole be submerged into the concrete pad for proper installation. The end user must check the local codes and ordinances for minimum depth required for safe installation.

Ordering Example: SMB1-** / SMB-J12 / SHD1-PC1023CL

(Surface Mount Base / J-Bolts / Fixture-Globe)

DIRECT BURIAL ALUMINUM LIGHT POLES

SMOOTH POLES

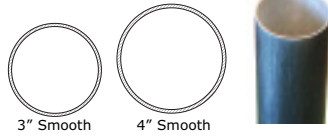

3" Smooth 4" Smooth

	Over All Pole Length				
	8' Length	10' Length	12' Length	14' Length	16' Length
3" O/D Smooth Pole Smooth Wall Pole	Model # 408	Model # 410	Model # 412	Model # 414	Model # 416
4" O/D Smooth Pole Smooth Wall Pole	608	610	612	614	616

FLUTED POLES

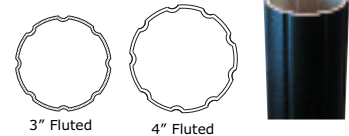

3" Fluted 4" Fluted

	Over All Pole Length				
	8' Length	10' Length	12' Length	14' Length	16' Length
3" O/D Fluted Pole	Model # MP-408	Model # MP-410	Model # MP-412	Model # MP-414	Model # MP-416
4" O/D Fluted Pole	MP-608	MP-610	MP-612	MP-614	MP-616

BASES

WRAP AROUND BASES

For use with Direct Burial Poles.



WRB1
Wrap Around Base
for 3" O/D poles
26" Height
7 1/2" Dia.



WRB6 for 3" O/D poles
WRB9 for 4" O/D poles
Wrap Around Base
32" Height
11 3/4" Dia.



WRB8
Wrap Around Base
for 3" O/D poles
10 1/4" Height
9 1/4" Dia.



WRB11
Wrap Around Base
for 4" O/D poles
16" Height
13" Dia.

SURFACE MOUNT POLES

Pole heights available in 8 ft., 10 ft., 12 ft., and 14 ft. lengths.



SMB1-**
Surface Mount Unit
with 3" O/D fluted pole
32" Base Height x
11 3/4" Dia.



SMB2-**
Surface Mount Unit
with 3" O/D fluted pole
48" Base Height x
11 1/2" Width

"J-Bolts"
Anchor Bolts
sold separately,
see page 15 for
part information

Direct Burial Poles: Requires a minimum of 18" of the pole be submerged into the concrete pad for proper installation. The end user must check the local codes and ordinances for minimum depth required for safe installation. **Surface Mount Poles:** The SMB1 and SMB2 units may be mounted to a concrete pad by means of "J"-bolts embedded in the concrete (sold separately).

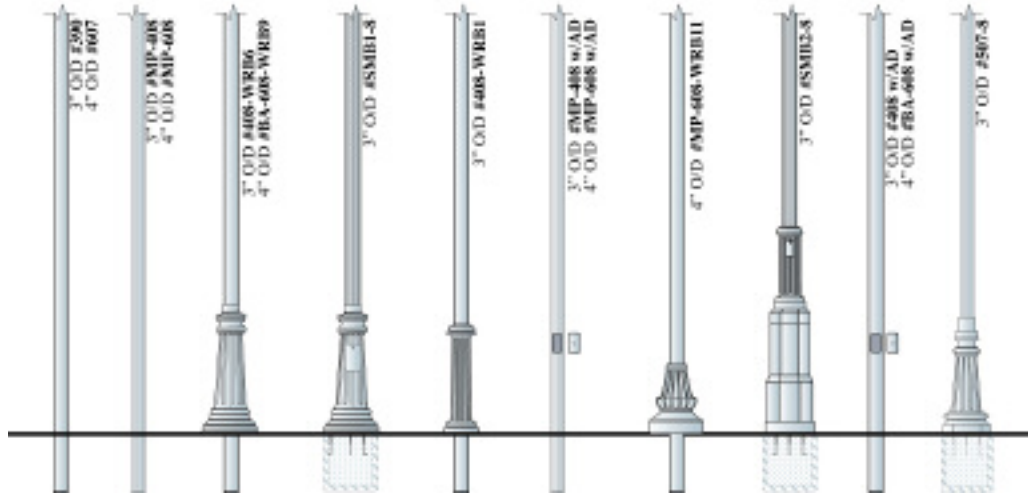

3" POLE DESCRIPTION AND MODEL NUMBERS

Description	7' Model #	8' Model #	10' Model #	12' Model #	14' Model #	16' Model #
3" O/D Smooth Pole	390	408	410	412	414	416
3" O/D Fluted Pole	MP-407	MP-408	MP-410	MP-412	MP-414	MP-416
3" O/D Smooth Pole w/ WRB6 Base**	390-WRB6	408-WRB6	410-WRB6	412-WRB6	414-WRB6	416-WRB6
Surface Mount Base w/ 3" O/D Fluted Pole and Access Door	N/A	SMB1-8	SMB1-10	SMB1-12	SMB1-14	N/A
3" O/D Smooth Pole w/ WRB1 Base**	390-WRB1	408-WRB1	410-WRB1	412-WRB1	414-WRB1	416-WRB1
3" O/D Fluted Pole w/ Access Door	MP-407-w/AD	MP-408-w/AD	MP-410-w/AD	MP-412-w/AD	MP-414-w/AD	MP-416-w/AD
Surface Mount Base w/ 3" O/D Fluted Pole and Access Door	N/A	SMB2-8	SMB2-10	SMB2-12	SMB2-14	N/A
3" O/D Smooth Pole w/ Access Door	390-w/AD	408-w/AD	410-w/AD	412-w/AD	414-w/AD	416-w/AD
3" O/D Fluted Pole and Sculpted Base	N/A	507-8	507-10	507-12	N/A	N/A

4" POLE DESCRIPTION AND MODEL NUMBERS

Description	7' Model #	8' Model #	10' Model #	12' Model #	14' Model #	16' Model #
4" O/D Smooth Pole	607	608	610	612	614	616
4" O/D Fluted Pole	MP-607	MP-608	MP-610	MP-612	MP-614	MP-616
4" O/D Smooth Pole w/ WRB9 Base**	607-WRB9	608-WRB9	610-WRB9	612-WRB9	614-WRB9	616-WRB9
4" O/D Smooth Pole w/ WRB11 Base**	607-WRB11	608-WRB11	610-WRB11	612-WRB11	614-WRB1	616-WRB11
4" O/D Fluted Pole w/ Access Door	MP-607-w/AD	MP-608-w/AD	MP-610-w/AD	MP-612-w/AD	MP-614-w/AD	MP-616-w/AD
4" O/D Smooth Pole w/ Access Door	607-w/AD	608-w/AD	610-w/AD	612-w/AD	614-w/AD	616-w/AD

** = Pole and Base are priced separately

TRI-LIGHT FIXTURES



Tri-Light Fixtures add elegance and beauty to your HOA, office or business development. Tri-Light fixtures can be created with many of our decorative outdoor light fixtures and are available in medium and large sizes. See our Lighting Catalog or call to learn more about our available options.

Tri-lights can be interchanged with different bases. All of our fixtures are available in 14 durable powder coated finishes. Our standard large Tri-Light Post height is 114".

Shown:

F-3990-Tri-light mounted on a SMB1-12 pole.

DECORATIVE LIGHTING / H.I.D. BALLASTS



METAL HALIDE AND HIGH PRESSURE SODIUM BALLASTS

Turn Special Lite's decorative outdoor post lights into H.I.D. light fixtures with a H.I.D. Ballast. Ballasts shown are designed to fit inside 3" and 4" O/D posts. All ballasts are provided with a metal hanger strap for suspension inside the top of the post. (See our Lighting Catalog or website to view complete line of decorative post lights. See our General Lighting Catalog for more decorative fixture options.)

MH-50

Metal Halide

- Produces a pure white light
- Enormous amount of light with excellent color rendering
- Bulbs last six times longer than incandescent

HID Lighting is available on all single post mounted lanterns or as a separate kit to retrofit an existing light.

The Kit contains:

- Canister Ballast
 - Mounting Bracket
 - Heavy Duty medium base socket
- Bulbs sold separately*

HPS-35 / HPS-50 / HPS-70 / HPS-100 / HPS-150 High Pressure Sodium

- Produces a golden-pink cast
- Bulbs rated at 24,000 hours

Ordering with a post lamp:

Specify type of ballast using corresponding products number, then the fixture number, finish, and glass choice.

Example: MH-50 F-2730-BL-BV

Not for use with Tri-Lights or Combination Twin Lanterns.

Ordering kit by itself:

Specify type of ballast using corresponding products number.

Example: MH-50

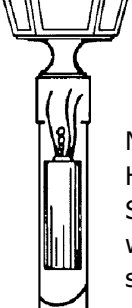
BALLAST	BALLAST SPECS.				INSTALLATION
	Item #	Wattage	Light Output (lumens)	Lamp Life (hours)	
	MH-50	50	2,000	24,000	
	HPS-35	35	2,000	16,000	
	HPS-50	50	4,000	24,000	
	HPS-70	70	6,300	24,000	
	HPS-100	100	8,000	24,000	
	HPS-150	150	9,000	24,000	

Metal Halide
High Pressure
Sodium installation
with canister
suspended in post.

4" ROUND SIGNAGE POLES

Our 4" O/D round traffic poles and accessories are made of high quality, commercial grade aluminum. Perfect to improve your downtown streetscape or business development.

- Thick inner walls for extra strength
- FHWA approved breakaway poles available
- Rust free extruded aluminum
- Durable powder coated finish
- Available in 14 finishes
- Poles available in 8 ft., 10 ft., 12 ft., 14 ft., and 16 ft. lengths.



3" Smooth Breakaway Approved

4" Smooth Breakaway Approved

Smooth Pole

3" Fluted

4" Fluted

Fluted Pole

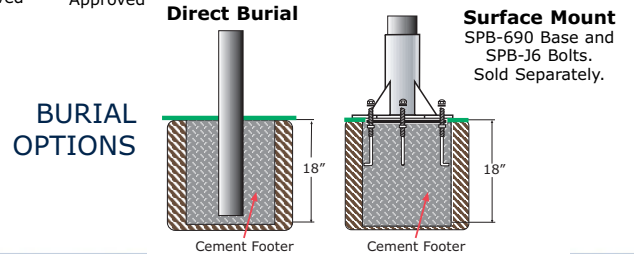



James Blvd



Yolanda St



Kiski Court



Breakaway Poles Available.
See page 31 for details.

See pages 26 - 31
for all 4" O/D round
pole accessories.

- **MP-614** (4" Fluted Direct Burial Pole)
- **TSB-601** (Street Sign Frame)
- **WRB9** (Wrap Around Base)
- **TSB60** (Cannon Ball Pole Topper)
- Optional Street Name Sign

- **MP-614** (4" Fluted Direct Burial Pole)
- **TSB-609** (Street Sign Mount)
- **TSB60** (Cannon Ball Pole Topper)
- Optional Street Name Sign

- **MP-614** (4" Fluted Direct Burial Pole)
- **TSB-203** (Street Sign Mount)
- **WRB9** (Wrap Around Base)
- **TSB64** (Acorn Pole Topper)
- Optional Street Name Sign

4" ROUND SIGNAGE POLES



*Breakaway Poles Available.
See page 31 for details.*

- **MP-614** (4" Fluted Direct Burial Pole)
- **TSB-608 x 2** (Two Street Sign Mounts)
- **WRB11** (Wrap Around Base)
- **TSB60** (Cannon Ball Pole Topper)
- Optional Street Name Signs

- **MP-614** (4" Fluted Direct Burial Pole)
- **TSB-601-DBL** (Double Street Sign Mount)
- **WRB9** (Wrap Around Base)
- **TSB64** (Acorn Pole Topper)
- Optional Street Name Signs

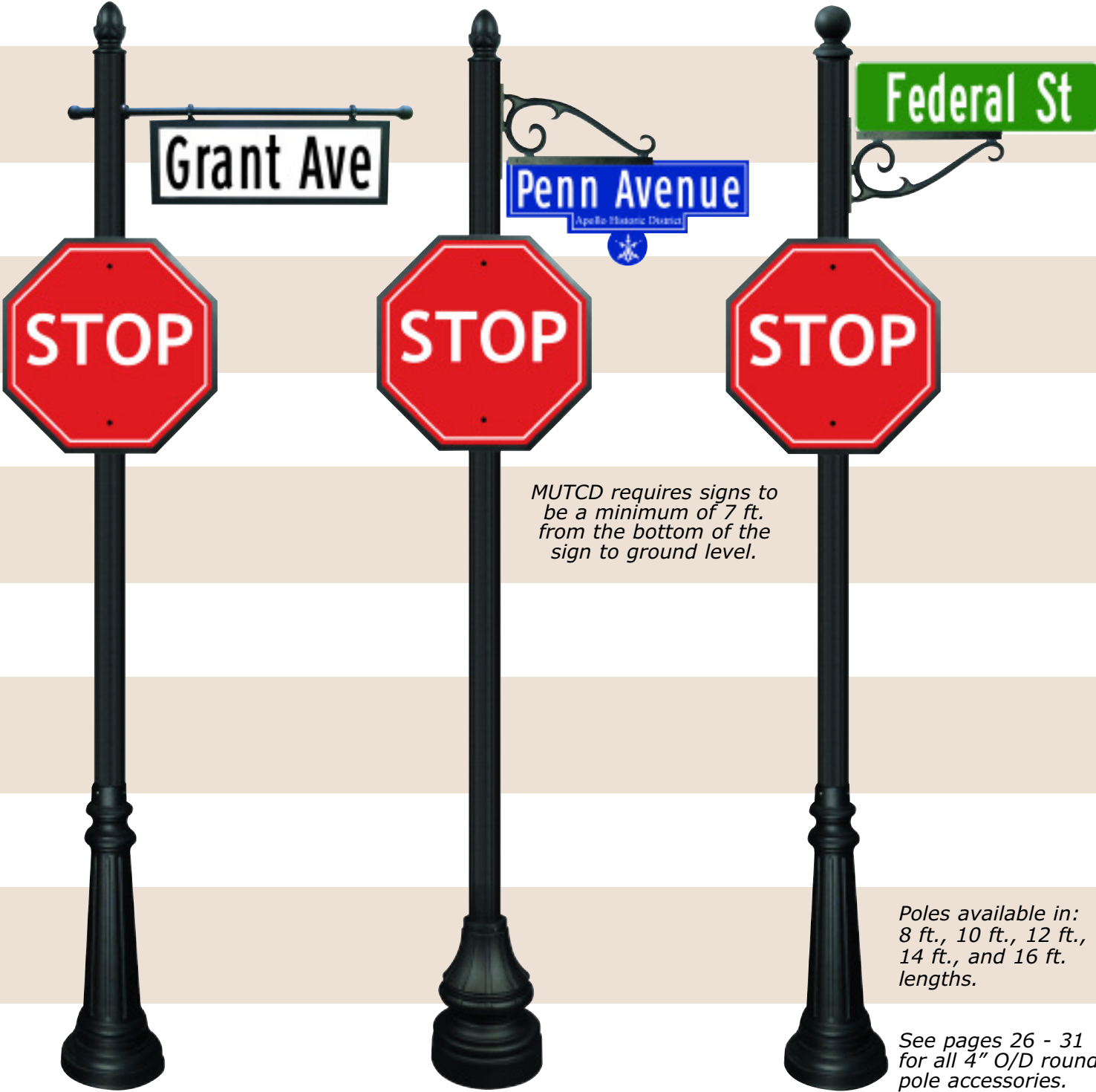

MUTCD requires signs to be a minimum of 7 ft. from the bottom of the sign to ground level.

Poles available in: 8 ft., 10 ft., 12 ft., 14 ft., and 16 ft. lengths.

See pages 26 - 31 for all 4" O/D round pole accessories.

- **MP-614** (4" Fluted Direct Burial Pole)
- **TSB-608** (Street Sign Mount)
- **BP24-OCT** (Back Plate for 24" Stop Sign)
- **TSB61** (Back Plate Mounting Brackets)
- **WRB9** (Wrap Around Base)
- **TSB64** (Acorn Pole Topper)
- Optional Street Name Sign and Stop Sign

- **MP-614** (4" Fluted Direct Burial Pole)
- **TSCR-700** (Street Sign Mount)
- **BP24-OCT** (Back Plate for 24" Stop Sign)
- **TSB61** (Back Plate Mounting Brackets)
- **WRB11** (Wrap Around Base)
- **TSB64** (Acorn Pole Topper)
- Optional Street Name Sign and Stop Sign

- **MP-614** (4" Fluted Direct Burial Pole)
- **TSCR-700** (Street Sign Mount)
- **BP24-OCT** (Back Plate for 24" Stop Sign)
- **TSB61** (Back Plate Mounting Brackets)
- **WRB9** (Wrap Around Base)
- **TSB60** (Cannon Ball Pole Topper)
- Optional Street Name Sign and Stop Sign

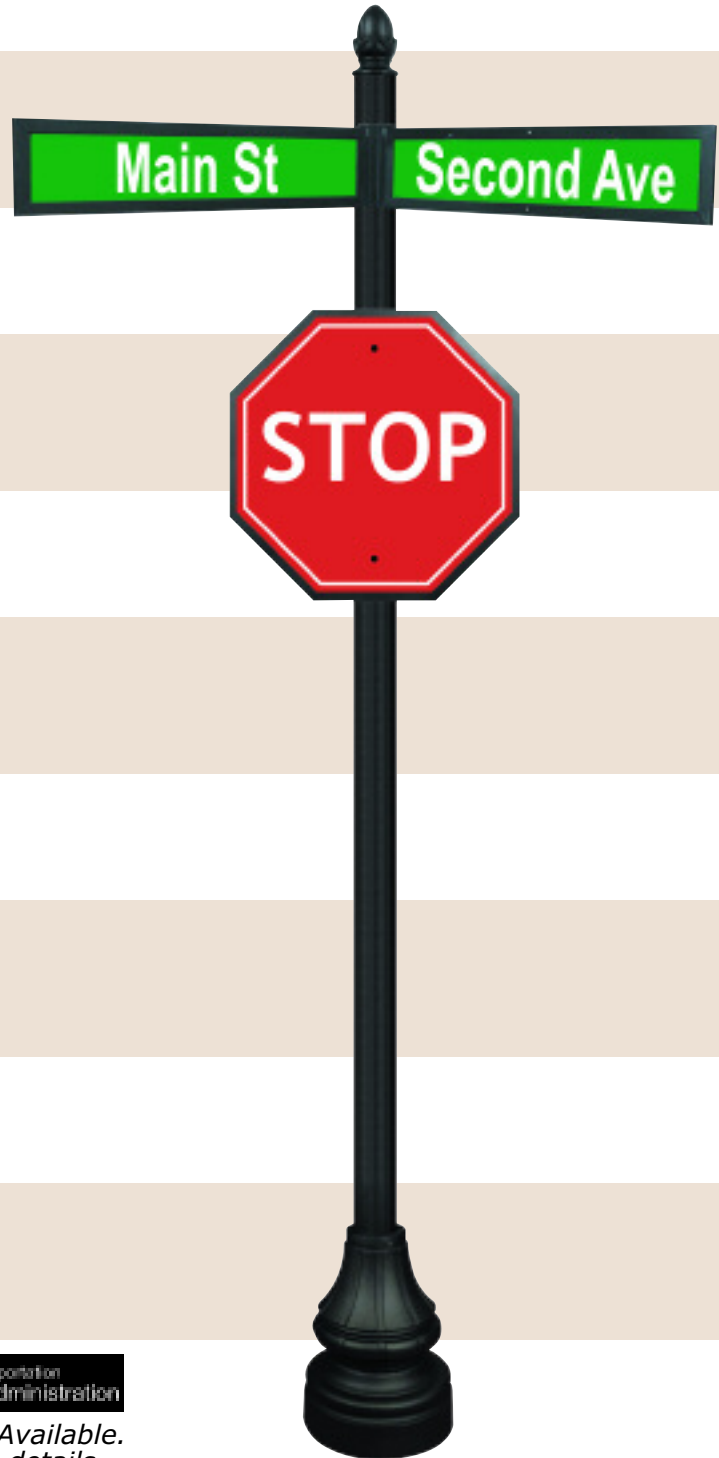
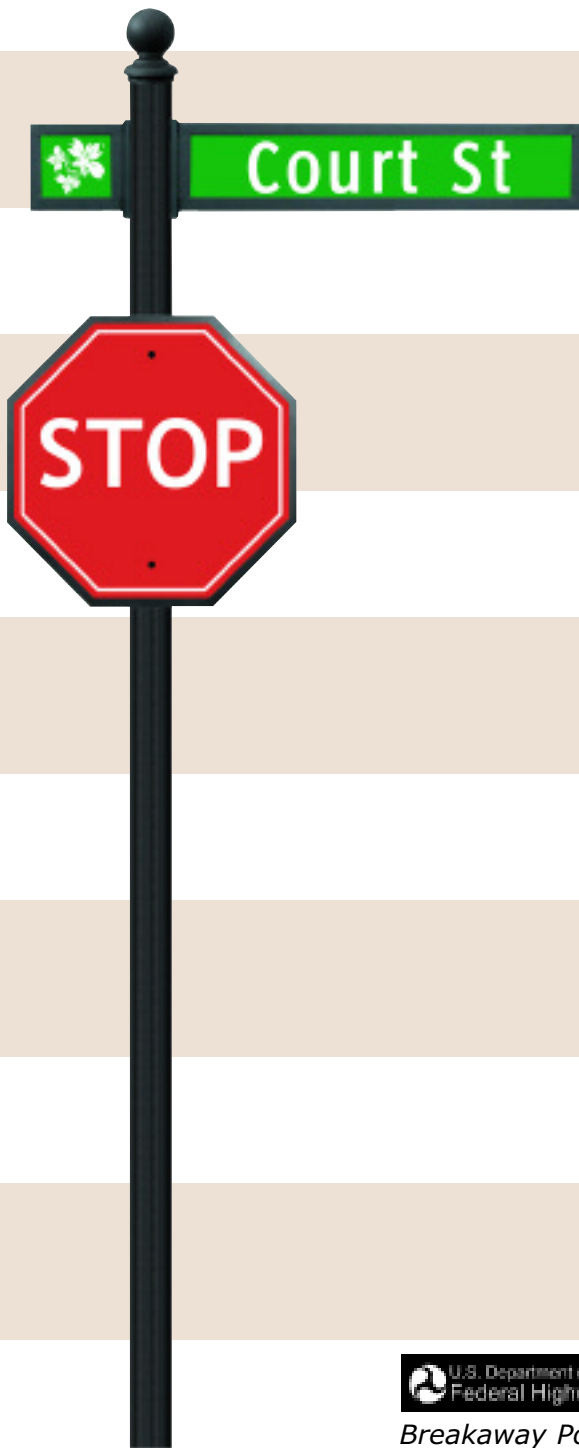

*Breakaway Poles Available.
See page 31 for details.*

- **MP-614** (4" Fluted Direct Burial Pole)
- **TSB-203-624** (Street Sign Mount)
- **TSB-203-66** (Logo Sign Mount)
- **BP24-OCT** (Back Plate for 24" Stop Sign)
- **TSB61** (Back Plate Mounting Brackets)
- **TSB60** (Cannon Ball Pole Topper)
- Optional Street Name Sign, Logo Sign and Stop Sign

- **MP-614** (4" Fluted Direct Burial Pole)
- **TSB-605-DBL** (Double Street Sign Mount)
- **BP24-OCT** (Back Plate for 24" Stop Sign)
- **TSB61** (Back Plate Mounting Brackets)
- **WRB11** (Wrap Around Base)
- **TSB64** (Acorn Pole Topper)
- Optional Street Name Signs and Stop Sign

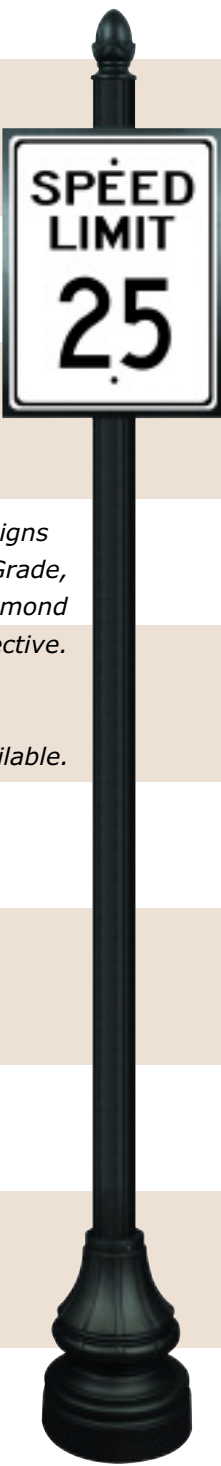
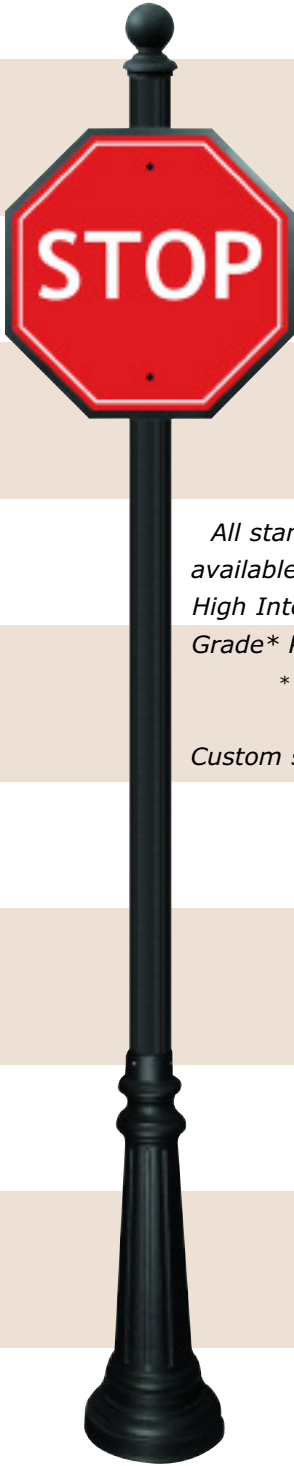

All standard D.O.T. signs available in Engineer Grade, High Intensity and Diamond Grade Prismatic Reflective.*

** when applicable*

Custom signs also available.

- **MP-614** (4" Fluted Direct Burial Pole)
- **BP24-OCT** (Back Plate for 24" Stop Sign)
- **TSB61** (Back Plate Mounting Brackets)
- **WRB9** (Wrap Around Base)
- **TSB60** (Cannon Ball Pole Topper)
- Optional Stop Sign

- **MP-614** (4" Fluted Direct Burial Pole)
- **BP-1824** (Back Plate for 18" x 24" Sign)
- **TSB61** (Back Plate Mounting Brackets)
- **WRB11** (Wrap Around Base)
- **TSB64** (Acorn Pole Topper)
- Optional D.O.T. Sign



Enhance the visual appearance of your signs with a Sign Frame or Back Plate. See page 28 for more details.

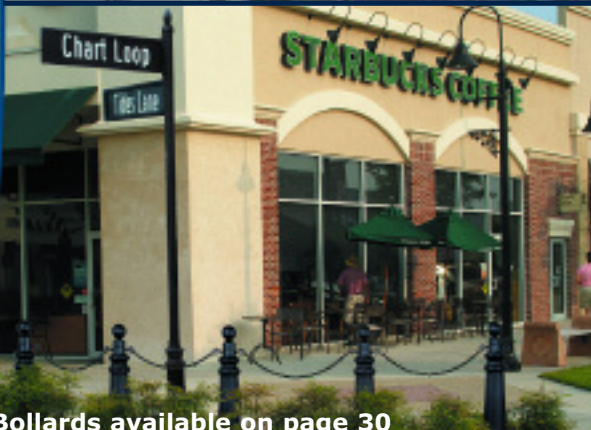

Bollards available on page 30

HOW TO ORDER

Our Direct Burial Poles and accessories are made of Extruded Aluminum and Cast Aluminum and are available in your choice of 14 durable powder coated base finishes. Poles require a minimum of 18" of the pole be submerged into the concrete pad for proper installation. The end user must check the local codes and ordinances for minimum depth required for safe installation.

Ordering Example: MP-612 / WRB9 / TSB-601 / TSB60.

(4"x12' Fluted Pole / Town Square Base / Single Sign Mount / Pole Topper)

Our **smooth pole is breakaway approved** by the U.S. Federal Highway Administration (FHWA). Our fluted pole requires a breakaway pole kit (sold separately) to be a FHWA approved breakaway pole. See page 31 for additional information.

STEP 1 - POLE TOPPERS

All toppers completely cover the top of the post to keep out the elements. Made of cast aluminum.



TSB60
5" W x
7 1/2" H



TSB64
3 7/8" W x
7 1/2" H



TSB65
4 1/2" W x
7 3/4" H

STEP 2 - 4" O/D ROUND POLES

4" O/D Extruded Aluminum Poles.
(Breakaway Poles Are Federal Highway Administration Approved).

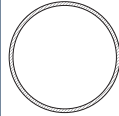

**4" O/D
Smooth
Breakaway
Pole**
Smooth Wall Pole

Over All Pole Length

8' Length	10' Length	12' Length	14' Length	16' Length
Model # BA-608	Model # BA-610	Model # BA-612	Model # BA-614	Model # BA-616
Model # MP-608	Model # MP-610	Model # MP-612	Model # MP-614	Model # MP-616

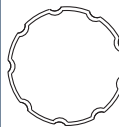

**4" O/D
Fluted Pole**
See page 31 for
breakaway pole
kit

STEP 3 - BASES

Bases fit over a 4" poles to add a decorative touch to the pole. Made of cast aluminum with a powder coated finish.



WRB9
Town Square Series
Wrap Around Base
32" Height
11 3/4" Dia.



WRB11
Large Americana
Slip Over Base
16" Height
13" Dia.



STEP 4 - STREET SIGN MOUNTING

The TSB series of Street Sign Holders can be ordered to hold any size Sign Blade. Add the height and length of the Sign Blade in inches to the end of the item number of the desired sign. For example: for a 6" x 24" Sign Blade in a TSB601 bracket the item number would be TSB601-624. Length of the arm's bar will vary with the length of the Sign Blade. Sign Blades sold separately.

TSCR-600

Clamps around 4" O/D round poles.
Scroll: 16" W x 5 1/2" H.

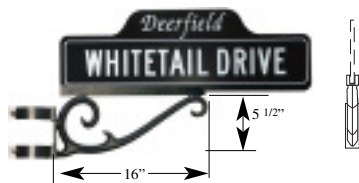

TSCR-700

Bolts to any Special Lite pole.
Scroll: 16" W x 5 1/2" H.



TSCR-600-DBL

Two TSCR brackets welded together at a 90° angle. Clamps around 4" O/D round poles. Scroll: 16" W x 5 1/2" H.



TSB-601

Clamps around 4" O/D round poles.
TSB-601-624: holds 6" x 24" sign.
Scroll: 16" W x 5 1/2" H.



TSB-601-DBL

Two TSB-601 brackets welded together at a 90° angle. Clamps around 4" O/D round poles. Scroll: 16" W x 5 1/2" H.



TSB-202

Bolts to any Special Lite pole.
TSB-202-624: holds 6" x 24" sign.
Scroll: 16" W x 5 1/2" H.



TSB-203-66 TSB-203-624

Bolts to any Special Lite pole.
Use model # TSB-203-624 to order without Logo Frame.



TSB-605

Clamps around 4" O/D round poles.
TSB-605-624: holds 6" x 24" sign.



TSB-605-DBL

Two TSB-605 brackets welded together at a 90° angle. Clamps around 4" O/D round poles.



TSB-608

For use with 4" O/D round poles
(shown mounted to smooth pole - sold separately.)



TSB-608-DBL

For use with 4" O/D round poles.
(shown mounted to smooth pole with TSB2 pole topper - both sold separately.)



TSB-609

For use with 4" O/D round poles.
(shown mounted to smooth pole with TSB2 pole topper - both sold separately.)



TSB-610

for use with 4" O/D round poles.
(shown mounted to smooth pole - sold separately.)









TSCR-600 Street Sign Mount with 30" x 6" custom street name sign.

STEP 5 - POLE TOP MOUNTING BRACKETS & FINIALS

<p>TSB3 Finial for flat street blade. TSB3-X Extruded street blade finial.</p> 	<p>TSB8 Finial for flat street blade. TSB8-X Extruded street blade finial.</p> 	<p>TRO Fits 3" O/D round poles. Holds one flat or extruded street blade.</p> 	<p>DBL Fits on top of flat street blade. Holds one flat street blade. DBL-X holds extruded blades.</p> 	<p>TSB15 4" to 3" pole Adapter. Easily attach mounting brackets or light fitters to a 4" O/D pole.</p> 
--	--	---	---	---

SIGN MOUNTING BRACKETS & HARDWARE

<p>TSB1 - For 3" O/D poles TSB61 - For 4" O/D poles Pole sign bracket / hardware (set of 2)</p> 	<p>TSB9 - For 3" O/D poles TSB62 - For 4" O/D poles Sign bracket / hardware for back to back signage mount (set of 2)</p> 	<p>TSB14 - For 3" O/D poles TSB63 - For 4" O/D poles Pole sign bracket / hardware (set of 2)</p>  <p>TSB14 & TSB63 Mounting Example</p> 	<p>TSB13 Vandal proof nuts (pack of 10)</p> 	<p>BP24-OCT mounted with TSB1 brackets</p> 
--	---	---	--	---

STEP 6 - TRAFFIC SIGN BACK PLATES

Measurements are for the Sign Blade going onto the backplate. Backplates have a 1" wide edge on all sides. The Traffic back plates are provided undrilled for custom mounting. To order a custom backplate use the item number BP followed by the height then the width of the sign. For example: to order a Back Plate for a 24" x 30" sign the item number would be BP-2430.

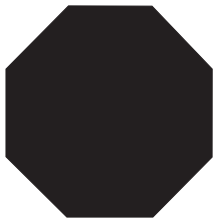

24" Back Plate BP24-OCT
30" Back Plate BP30-OCT



24" x 24" Back Plate BP-2424
30" x 30" Back Plate BP-3030



12" x 18" Back Plate BP-1218
18" x 24" Back Plate BP-1824

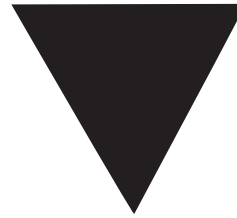

30" Back Plate BP30-TRI
36" Back Plate BP36-TRI
measurement is point to point

TRAFFIC SIGN FRAMES

Measurements are for the Sign Blade going into the frame. Sign Frames have a 1" square edge on all sides. To order a custom Sign Frame, use the item number SF followed by the height then the width of the sign. For example: to order a Frame for a 18" x 24" sign the item number would be SF-1824.



24" Frame SF24-OCT
30" Frame SF30-OCT



24" x 24" Frame SF-2424
30" x 30" Frame SF-3030



12" x 18" Frame SF-1218
18" x 24" Frame SF-1824



30" Frame SF30-TRI
36" Frame SF36-TRI
measurement is point to point

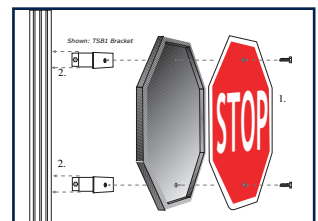

Sign Frame or Back Plate mounting diagram

Street name and regulatory signs must conform to the Manual on Uniform Traffic Control Devices (MUTCD). Always check with your local ordinance or municipality to ensure size and reflective requirements are met or exceeded when purchasing traffic control signage.

STEP 7 - STREET NAME SIGNS

- Sign blades available in flat or extruded aluminum
- When the speed limit is 25 mph or less, use a minimum 6" high sign with 4" high letters
- When the speed limit is over 25 mph, use a minimum 9" high sign with 6" high letters
- MUTCD requires the use of capital & lower case letters (ex: Main Street)
- Signs need to have a reflective background sheeting (minimum of Engineer Grade Prismatic, High Intensity Prismatic is recommended)
- ** High Intensity Prismatic will be the required choice within the next few years.



Flat Aluminum Blade

6" High Blade

By necessary length



9" High Blade

By necessary length



Extruded Aluminum Blade

6" High Blade

By necessary length



9" High Blade

By necessary length



CUSTOM STREET SIGNS

- Special Lite Products can customize any basic street sign to provide a unique look or custom cut metal blades to create logos and other designs to make your signs stand out from the rest.



STEP 8 - D.O.T. REGULATORY AND INFORMATIONAL SIGNS

- Special Lite Products can provide you with all your regulatory signage needs.
- Signs available in Engineer Grade, High Intensity Prismatic and Diamond Grade Prismatic. (when applicable)

MUTCD requires signs to be mounted 7 ft. from the bottom of sign to ground level.

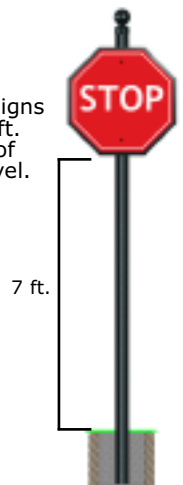

SITE ACCESSORIES



CAST ALUMINUM BOLLARDS

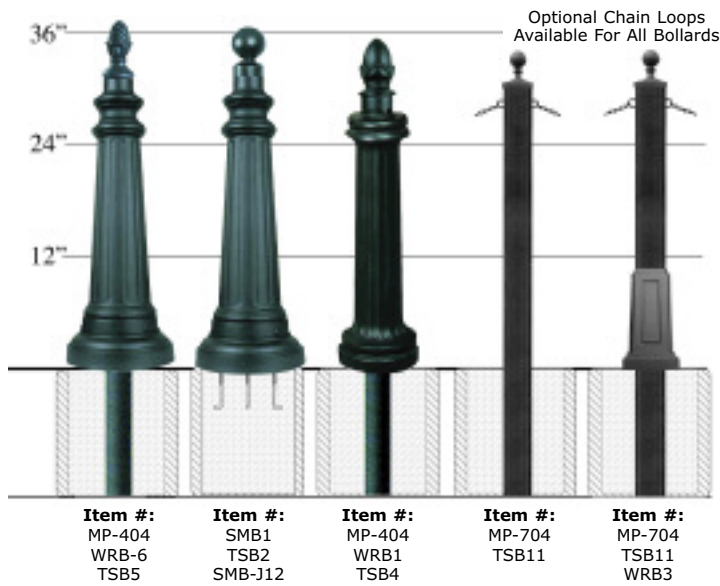

Bollards can be used at key locations to create a sense of separation between pedestrian and vehicular areas and to add visual interest to the streetscape. Please specify if chain loops are required. Bollards ship standard without chain loops.

LUMINATED BOLLARDS

Available in High Pressure Sodium, Metal Halide and LED.



- 41" standard height
- Extruded aluminum housing with flush mounting base.
- Internal ballast tray for easy maintenance.
- Clear polycarbonate glass lens.
- Max 100w HPS, 100w MH, 2x15w LED
- Mounting kit with 4 anchor bolts included
- CSA listed for wet locations

CRASH TESTS: We have not conducted nor do we intend to conduct a laboratory crash test. We do not boast or claim that given bollards will withstand any given force or impact for liability purposes. Bollards are manufactured and designed as a deterrent and precautionary boundary.



DECORATIVE PARKING METER KIT

Upgrade the look of your parking meters and streetscape by using decorative 3" O/D posts and either our WRB7 or WRB8 wrap around base to retro-fit your parking meters appearance. Simply remove the parking meter head from existing post and slide the 3" pole and base over existing pole, then replace parking meter head.

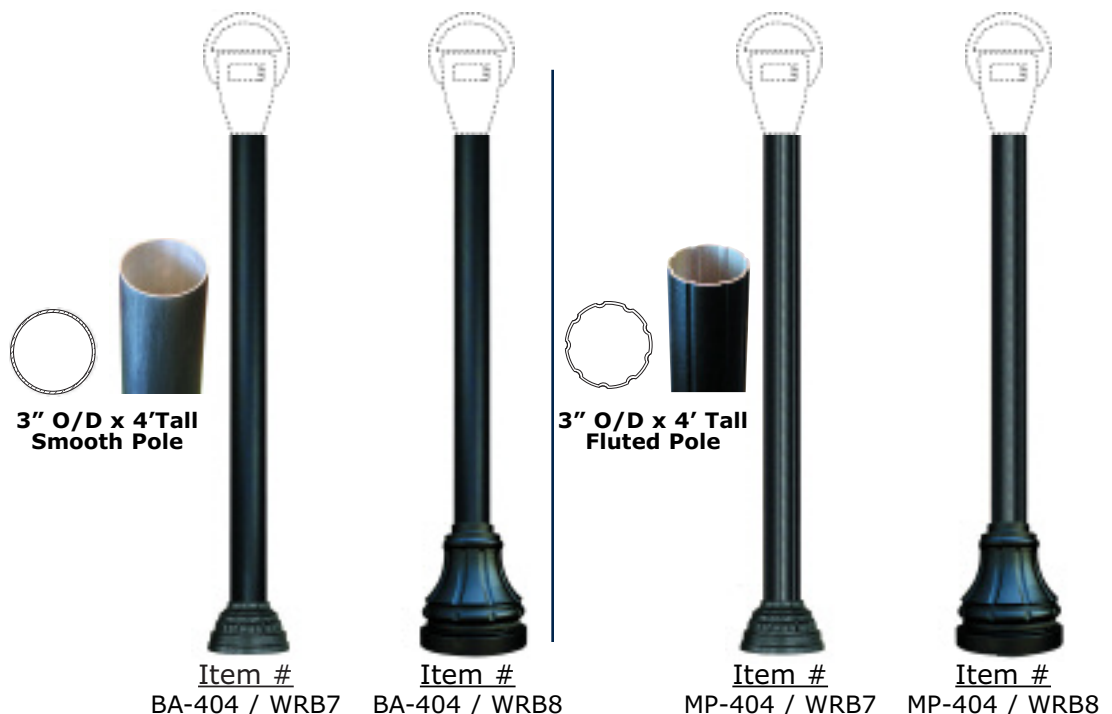

BREAKAWAY POLES

Our 3" and 4" O/D smooth poles meet U.S. Federal Highway Administration (FHWA) breakaway regulations.

Our decorative smooth poles are engineered and approved as a FHWA breakaway device suitable for traffic signage. No special adapter required. Breakaway poles are helpful in high-speed environments, where an unyielding sign pole could make an off-road traffic accident significantly worse.

Smooth breakaway poles are omni directional, meaning they don't require poles to face a certain direction and can easily be installed in multiple applications.

Item #:

BA-4** (3" O/D smooth breakaway pole).

BA-6** (4" O/D smooth breakaway pole).

** = length of pole (ex: BA-410 = 3" O/D x 10 ft. length)

Poles available in 8 ft., 10 ft., 12., 14 ft. and 16 ft. lengths.

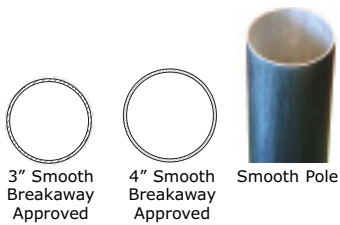

APPROVED BY THE:



(Our fluted poles require the breakaway pole kit to be breakaway compliant. See section below for additional information).



BREAKAWAY POLE KIT

By using the patented Breakaway Pole Kit our 3" and 4" O/D Fluted Poles are U.S. Federal Highway Administration breakaway compliant.

Flush-to-the-ground configuration allows sign poles to breakaway or release cleanly at ground-level, with a 360 degree impact zone. Other mounting systems extend above the ground level and can come in contact with a vehicles tires and/or gas tank upon impact causing roll-overs and explosions.

Once the breakaway pole kit is installed, you simply insert the fluted post and drive in the wedge, locking the post into the anchor without the need of any additional hardware.

APPROVED BY THE:



Item #:

VR3-

Breakaway Pole Kit for 3" O/D Pole.

VR4-

Breakaway Pole Kit for 4" O/D Pole.



High speed VR3 / VR4 anchor impact



Low speed VR3 / VR4 anchor impact

WAYFINDING & ENTRANCE SIGNAGE

Specially designed area directional and entrance signs can be placed throughout your community or business complex to direct motorists, bicyclists and pedestrians to key locations. Standard and custom size signs available. Signs can be made from a variety of materials. Add decorative poles, bases and toppers to create beautiful signage units for your community or commercial property. Call today for more information and pricing.



- **MP-708 x 2**
(4" Square Fluted Direct Burial Poles)
- **WRB3 x 2** (Wrap Around Bases)
- **TSB11 x 2** (Pole Toppers)
- Optional Entrance Sign



- **MP-408 x 3**
(3" O/D Fluted Direct Burial Poles)
- **TSB2 x 3**
(Pole Toppers)
- **TSB14**
(Sign Brackets)
- Optional Wayfinding Signs

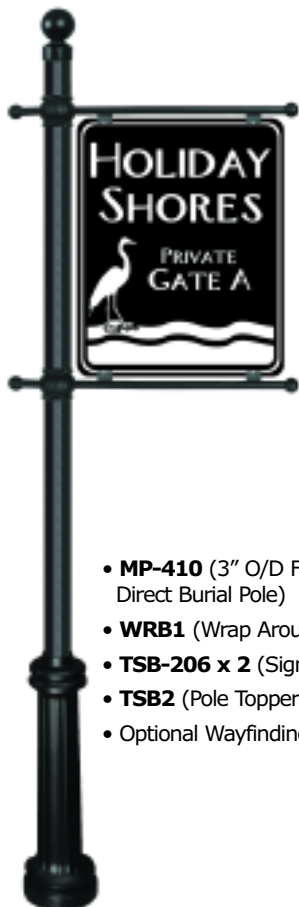

- **MP-410** (3" O/D Fluted Direct Burial Pole)
- **WRB1** (Wrap Around Base)
- **TSB-206 x 2** (Sign Mount)
- **TSB2** (Pole Topper)
- Optional Wayfinding Sign

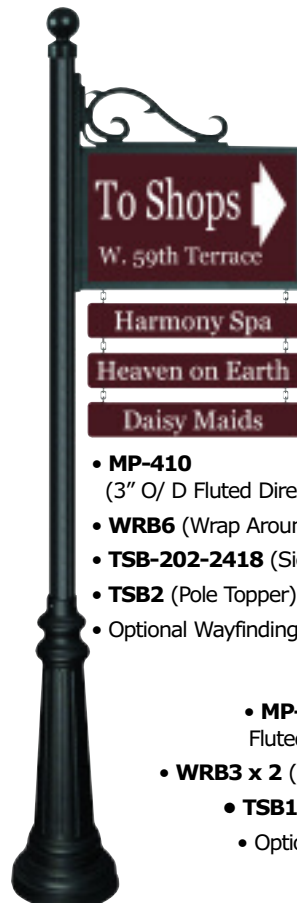

- **MP-410**
(3" O/ D Fluted Direct Burial Pole)
- **WRB6** (Wrap Around Base)
- **TSB-202-2418** (Sign Frame)
- **TSB2** (Pole Topper)
- Optional Wayfinding Signs



- **MP-712 x 2** (4" Square Fluted Direct Burial Poles)
- **WRB3 x 2** (Wrap Around Bases)
- **TSB11 x 2** (Pole Toppers)
- Optional Wayfinding Sign



- **MP-412 x 2**
(3" O/ D Fluted Direct Burial Poles)
- **WRB6 x 2** (Wrap Around Bases)
- **TSB-209-custom** (Sign Mount)
- **TSB-210-custom** (Sign Mount)
- **TSB2 x 2** (Pole Toppers)
- Optional Wayfinding Sign



WAYFINDING SIGNAGE UNITS CONTINUED



- **MP-406** (3" O/D Fluted Direct Burial Pole)
- **WRB6** (Wrap Around Base)
- **TSB2** (Pole Topper)
- **TSB14** (Sign Brackets)
- Optional Wayfinding Sign



- **MP-408** (3" O/D Fluted Direct Burial Pole)
- **WRB1** (Wrap Around Base)
- **TSB2** (Pole Topper)
- **SF-1824** (Sign Frame)
- **TSB1** (Sign Brackets)
- Optional Wayfinding Sign



PORTABLE SIGNAGE UNITS

Display your signage with our upscale portable signage units.

- Perfect for store fronts, churches, restaurants and more.
- Available in a variety of sizes and options that can be customized for your application.
- Easy access to change sign panel when needed.
- Posts can be direct burial or use our freestanding base.



- **MP-404** (3" O/D Fluted Pole)
- **SF-1824** (Sign Frame)
- **TRO-mod** (Adapter)
- **WRB8** (Wrap Around Base)
- **SPB-190** (Stub Post Base)
- Freestanding Base
- Optional Sign



- **MP-604** (4" Fluted Pole)
- **SF-2430** (Sign Frame)
- **TRO-mod** (Adapter)
- **WRB11** (Wrap Around Base)
- **SPB-690** (Stub Post Base)
- Freestanding Base
- Optional Sign



- **MP-405** (3" Fluted Pole)
- **SF-3024** (Sign Frame)
- **TRO-mod** (Adapter)
- **WRB6** (Wrap Around Base)
- **SPB-190** (Stub Post Base)
- Freestanding Base
- Optional Sign

STANDARD SIGN SHAPES

Want to create a unique look for your signs? We can provide the solution. Choose from any of our standard sign panels below or let us create the unique sign you are looking for.

Panels are made out of .080, 1/8" or 1/4" aluminum. Call today for more information.

Choose from our standard powder coated finishes, Engineer Grade or High Intensity Vinyl Backgrounds.

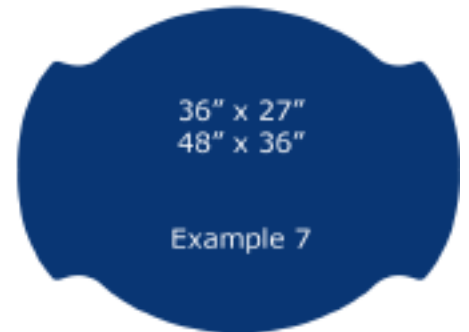
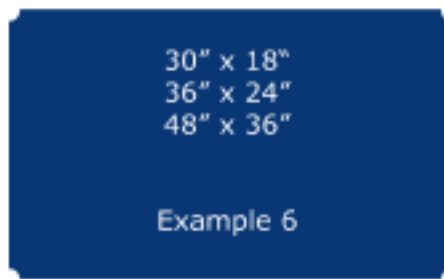
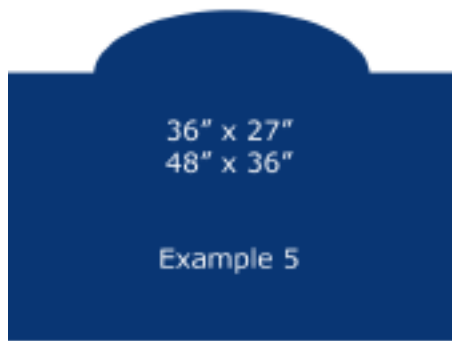
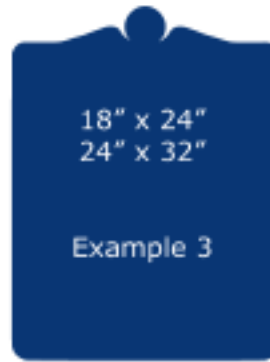
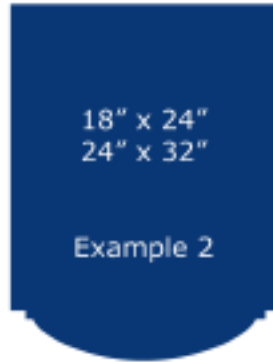
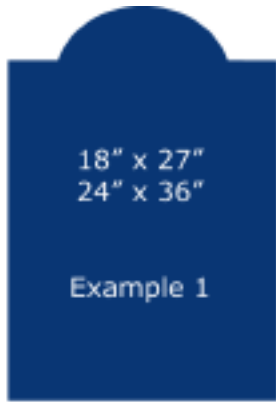

LOGO SIGNS

Create unity throughout your community or commercial property by using a custom logo on all your signage. Logos can be used on wayfinding signs, entrance signs, street name signs, etc.



3" O/D POLES & ACCESSORIES





VISTA SERIES

3" O/D DECORATIVE SIGNAGE POLES

See page 52 - 55 for ordering information

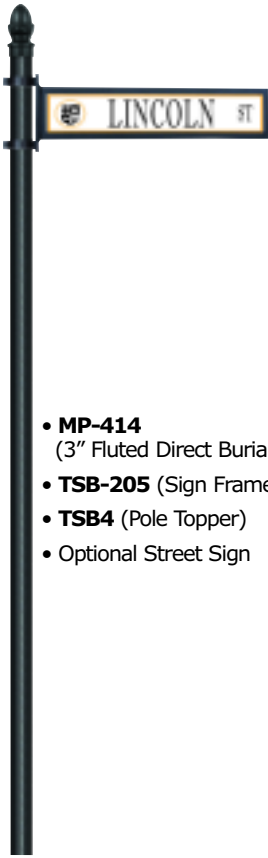

- **MP-414**
(3" Fluted Direct Burial Pole)
- **TSB-205** (Sign Frame)
- **TSB4** (Pole Topper)
- Optional Street Sign

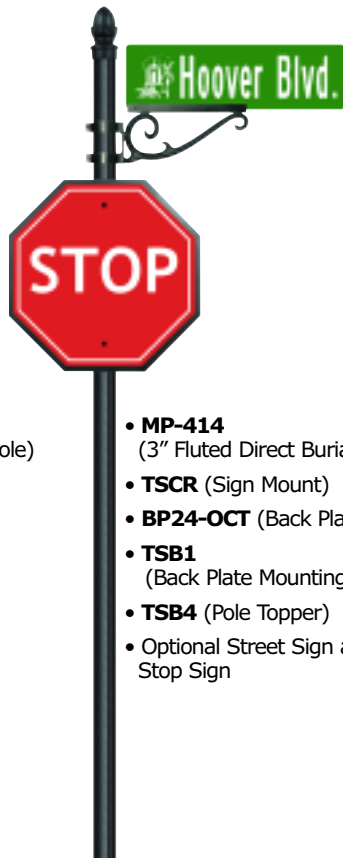

- **MP-414**
(3" Fluted Direct Burial Pole)
- **TSCR** (Sign Mount)
- **BP24-OCT** (Back Plate)
- **TSB1**
(Back Plate Mounting Brackets)
- **TSB4** (Pole Topper)
- Optional Street Sign and Stop Sign

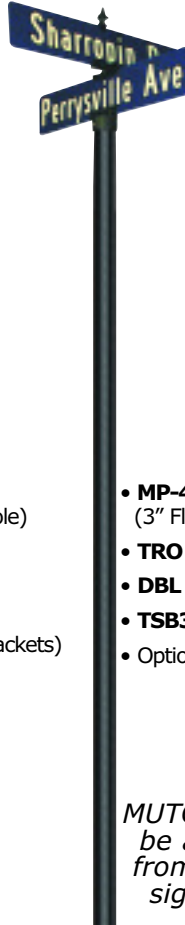

- **MP-414**
(3" Fluted Direct Burial Pole)
- **TRO** (Sign Bracket)
- **DBL** (Sign Bracket)
- **TSB3** (Finial)
- Optional Street Sign

MUTCD requires signs to be a minimum of 7 ft. from the bottom of the sign to ground level.

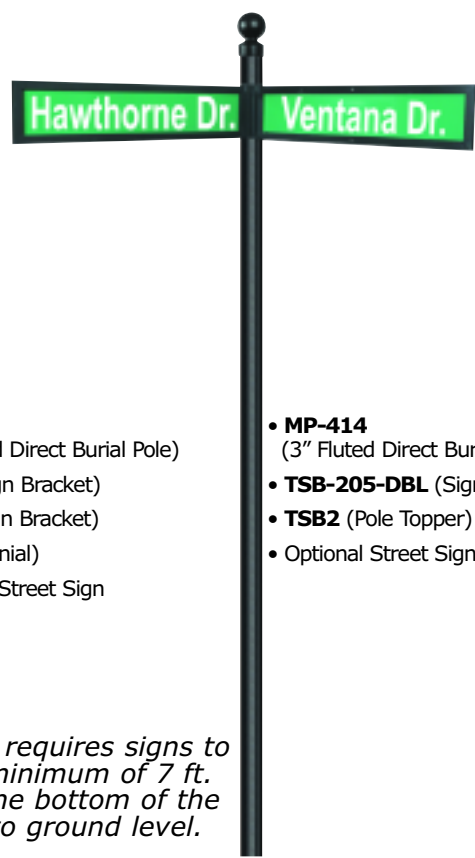

- **MP-414**
(3" Fluted Direct Burial Pole)
- **TSB-205-DBL** (Sign Frame)
- **TSB2** (Pole Topper)
- Optional Street Signs

Improve the appearance of your community by using the Vista Series pole as an upgrade from a standard U-Channel post. (All components sold separately.)

- Available in 3" and 4" O/D Poles (*see below*)
- 8 ft., 10 ft., 12 ft., 14 ft. & 16 ft. lengths available
- Rust free extruded aluminum
- Maintenance free powder coated finish
- Available in 14 finishes
- Coordinating cast aluminum lighting, mailboxes and posts available



See page 31 for details about our U.S. Federal Highway Administration approved Breakaway Poles

Pole Options

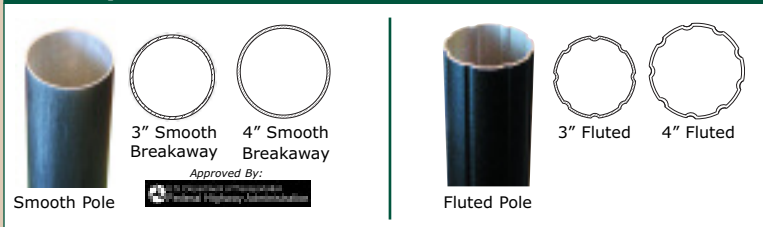

Burial Options

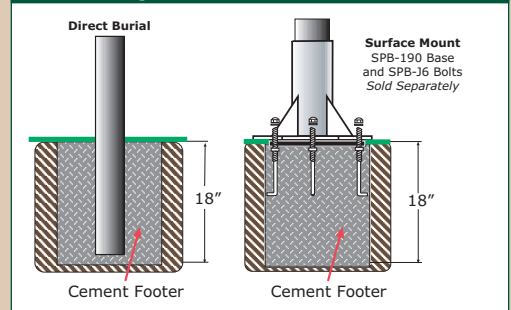



Breakaway Poles Available.
See page 31 for details.

3" O/D D.O.T. SIGN POLES

See page 52 - 55 for ordering information



- **MP-414**
(3" Fluted Direct Burial Pole)
- **BP24-OCT** (Back Plate)
- **TSB1** (Back Plate Mounting Brackets)
- **TSB2** (Pole Topper)
- Optional D.O.T. Sign



- **MP-414**
(3" Fluted Direct Burial Pole)
- **BP-2424** (Back Plate)
- **TSB1** (Back Plate Mounting Brackets)
- **TSB2** (Pole Topper)
- Optional D.O.T. Sign



- **MP-414**
(3" Fluted Direct Burial Pole)
- **BP-1824** (Back Plate)
- **TSB1** (Back Plate Mounting Brackets)
- **TSB2** (Pole Topper)
- Optional D.O.T. Sign



- **MP-414**
(3" Fluted Direct Burial Pole)
- **BP-2424** (Back Plate)
- **TSB1** (Back Plate Mounting Brackets)
- **TSB2** (Pole Topper)
- Optional D.O.T. Sign

*Poles available in:
8 ft., 10 ft., 12 ft.,
14 ft., and 16 ft.
lengths.*

WAYFINDING & INFORMATIONAL SIGNS

See pages 32 - 35 for additional wayfinding sign information



- **MP-408 x 2**
(3" Fluted Direct Burial Poles)
- **TSB4 x 2** (Pole Toppers)
- **TSB14 x 4** (Sign Brackets)
- Optional Wayfinding Sign



- **MP-406**
(3" Fluted Direct Burial Pole)
- **TSB1** (Back Plate Mounting Brackets)
- Optional Wayfinding Sign

DECORATIVE RESIDENTIAL & COMMERCIAL LIGHTING

See pages 4 - 19 for additional lighting information



- **MP-414**
(3" Fluted Direct Burial Pole)
 - **F-3970** (Post Light)
- Incandescent, Compact Fluorescent and H.I.D. Light Sources Available.



- **MP-414**
(3" Fluted Direct Burial Pole)
 - **SHD1-PC2020CL**
(Fixture and Globe)
- H.I.D.** and **L.E.D.** Light Sources Available

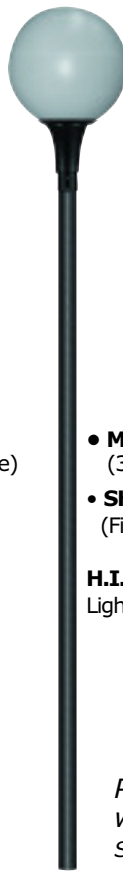

- **MP-414**
(3" Fluted Direct Burial Pole)
 - **SHD2-PC3018WH**
(Fixture and Globe)
- H.I.D.** and **L.E.D.** Light Sources Available

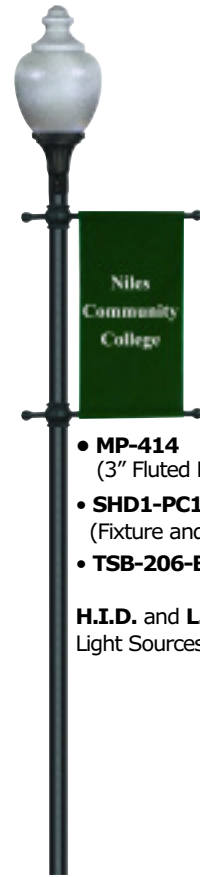

- **MP-414**
(3" Fluted Direct Burial Pole)
 - **SHD1-PC1023CL**
(Fixture and Globe)
 - **TSB-206-Banner Arm x 2**
- H.I.D.** and **L.E.D.** Light Sources Available

Poles also available with Access Door. See page 17 for details

CURBSIDE MAILBOX UNITS

See pages 56 - 59 for additional mailbox information



- **SPK-678**
(Direct Burial Mailbox Post)
- **SCV-1009**
(Curbside Mailbox)



- **SPK-679**
(Direct Burial Mailbox Post)
- **SCS-1014**
(Curbside Mailbox)





CLASSIC SERIES

3" O/D DECORATIVE SIGNAGE POLES

See page 52 - 55 for ordering information

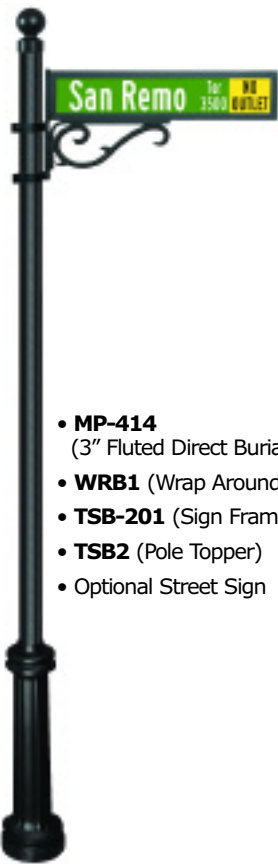

- **MP-414**
(3" Fluted Direct Burial Pole)
- **WRB1** (Wrap Around Base)
- **TSB-201** (Sign Frame)
- **TSB2** (Pole Topper)
- Optional Street Sign



- **MP-414**
(3" Fluted Direct Burial Pole)
- **WRB1** (Wrap Around Base)
- **TSB-206** (Sign Mount)
- **BP24-OCT** (Back Plate)
- **TSB1** (Back Plate Mounting Brackets)
- **TSB4** (Pole Topper)
- Optional Street Sign and Stop Sign

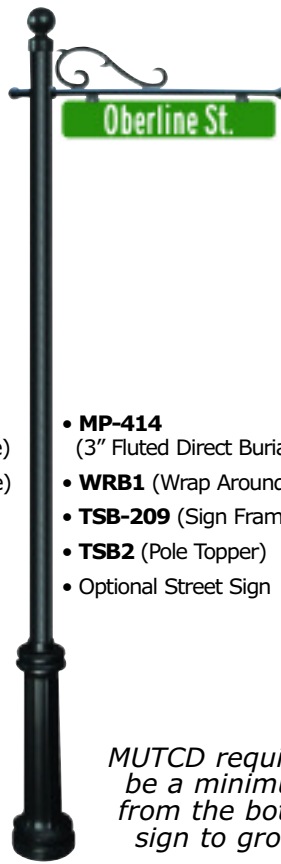

- **MP-414**
(3" Fluted Direct Burial Pole)
- **WRB1** (Wrap Around Base)
- **TSB-209** (Sign Frame)
- **TSB2** (Pole Topper)
- Optional Street Sign

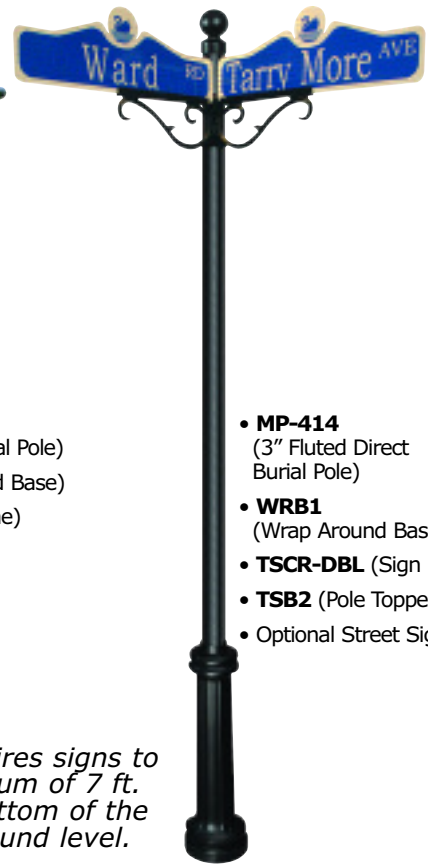

- **MP-414**
(3" Fluted Direct Burial Pole)
- **WRB1**
(Wrap Around Base)
- **TSCR-DBL** (Sign Mount)
- **TSB2** (Pole Topper)
- Optional Street Signs

MUTCD requires signs to be a minimum of 7 ft. from the bottom of the sign to ground level.

The Classic Series pole and base combination provides an upscale look that complements traditional and contemporary architecture. (All components sold separately.)

- Available in 3" O/D Poles (*see below*)
- 8 ft., 10 ft., 12 ft., 14 ft. & 16 ft. lengths available
- Fully sculpted wrap around base
- Rust free extruded aluminum
- Maintenance free powder coated finish
- Coordinating cast aluminum lighting, mailboxes and posts available



See page 31 for details about our U.S. Federal Highway Administration approved Breakaway Poles

Pole Options



Base Detail (26" H, 7 1/2" Dia.)



Burial Options

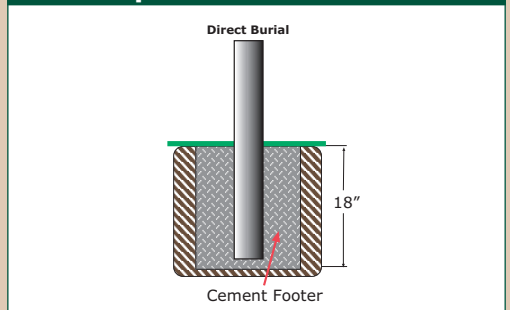



Breakaway Poles Available.
See page 31 for details.

3" O/D D.O.T. SIGN POLES
See page 52 - 55 for ordering information



- **MP-414**
(3" Fluted Direct Burial Pole)
- **WRB1** (Wrap Around Base)
- **BP-1824** (Back Plate)
- **TSB1** (Back Plate Mounting Brackets)
- **TSB2** (Pole Topper)
- Optional D.O.T. Sign

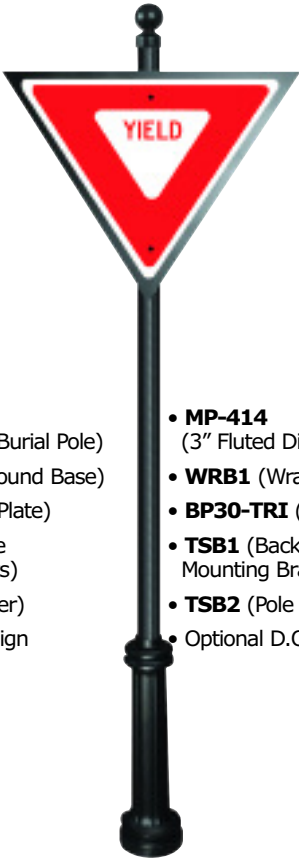

- **MP-414**
(3" Fluted Direct Burial Pole)
- **WRB1** (Wrap Around Base)
- **BP30-TRI** (Back Plate)
- **TSB1** (Back Plate Mounting Brackets)
- **TSB2** (Pole Topper)
- Optional D.O.T. Sign

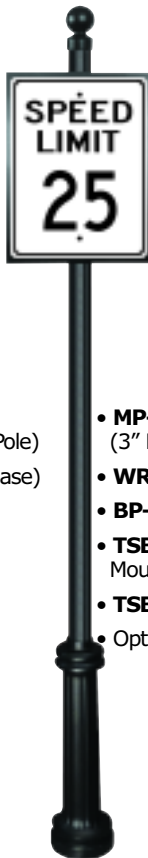

- **MP-414**
(3" Fluted Direct Burial Pole)
- **WRB1** (Wrap Around Base)
- **BP-1824** (Back Plate)
- **TSB1** (Back Plate Mounting Brackets)
- **TSB2** (Pole Topper)
- Optional D.O.T. Sign

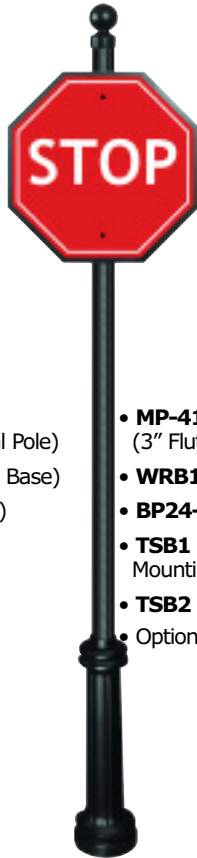

- **MP-414**
(3" Fluted Direct Burial Pole)
- **WRB1** (Wrap Around Base)
- **BP24-OCT** (Back Plate)
- **TSB1** (Back Plate Mounting Brackets)
- **TSB2** (Pole Topper)
- Optional D.O.T. Sign

WAYFINDING & INFORMATIONAL SIGNS

See page 32 - 35 for additional signage information



- **MP-408**
(3" Fluted Direct Burial Pole)
- **WRB1** (Wrap Around Base)
- **TSB-206** (Sign Mount)
- **TSB2** (Pole Topper)
- Optional Wayfinding Sign



- **MP-406 x 2**
(3" Fluted Direct Burial Poles)
- **WRB1 x 2** (Wrap Around Bases)
- **TSB14 x 4** (Sign Brackets)
- **TSB2 x 2** (Pole Toppers)
- Optional Wayfinding Sign

DECORATIVE RESIDENTIAL & COMMERCIAL LIGHTING

See pages 4 - 19 for additional lighting information



- **MP-414**
(3" Fluted Direct Burial Pole)
- **WRB1** (Wrap Around Base)
- **F-3960** (Post Light)

Incandescent, Compact Fluorescent and H.I.D. light sources available.



- **MP-414**
(3" Fluted Direct Burial Pole)
- **WRB1** (Wrap Around Base)
- **SHD1-PC1023CL**
(Fixture and Globe)

H.I.D. and L.E.D. Light Sources Available

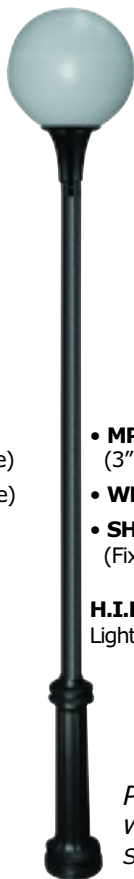

- **MP-414**
(3" Fluted Direct Burial Pole)
- **WRB1** (Wrap Around Base)
- **SHD2-PC3018WH**
(Fixture and Globe)

H.I.D. and L.E.D. Light Sources Available



- **MP-414**
(3" Fluted Direct Burial Pole)
- **WRB1** (Wrap Around Base)
- **SHD1-PC1023CL**
(Fixture and Globe)
- **PFIN** (Finial)
- **TSB-201-1824**
(Sign Frame)
- Optional Wayfinding Sign

H.I.D. and L.E.D. Light Sources Available

*Poles also available with Access Door.
See page 17 for details*

CURBSIDE MAILBOX UNITS

See pages 56 - 59 for additional mailbox information



- **SPK-592**
(Direct Burial Mailbox Post)
- **SCC-1008**
(Curbside Mailbox)



- **SPK-590**
(Direct Burial Mailbox Post)
- **STB-1007**
(Curbside Mailbox)



SPK-592 / SCC-2008 / MP-453 / BR2



TOWN SQUARE SERIES

3" O/D DECORATIVE TRAFFIC POLES

See page 52 - 55 for ordering information

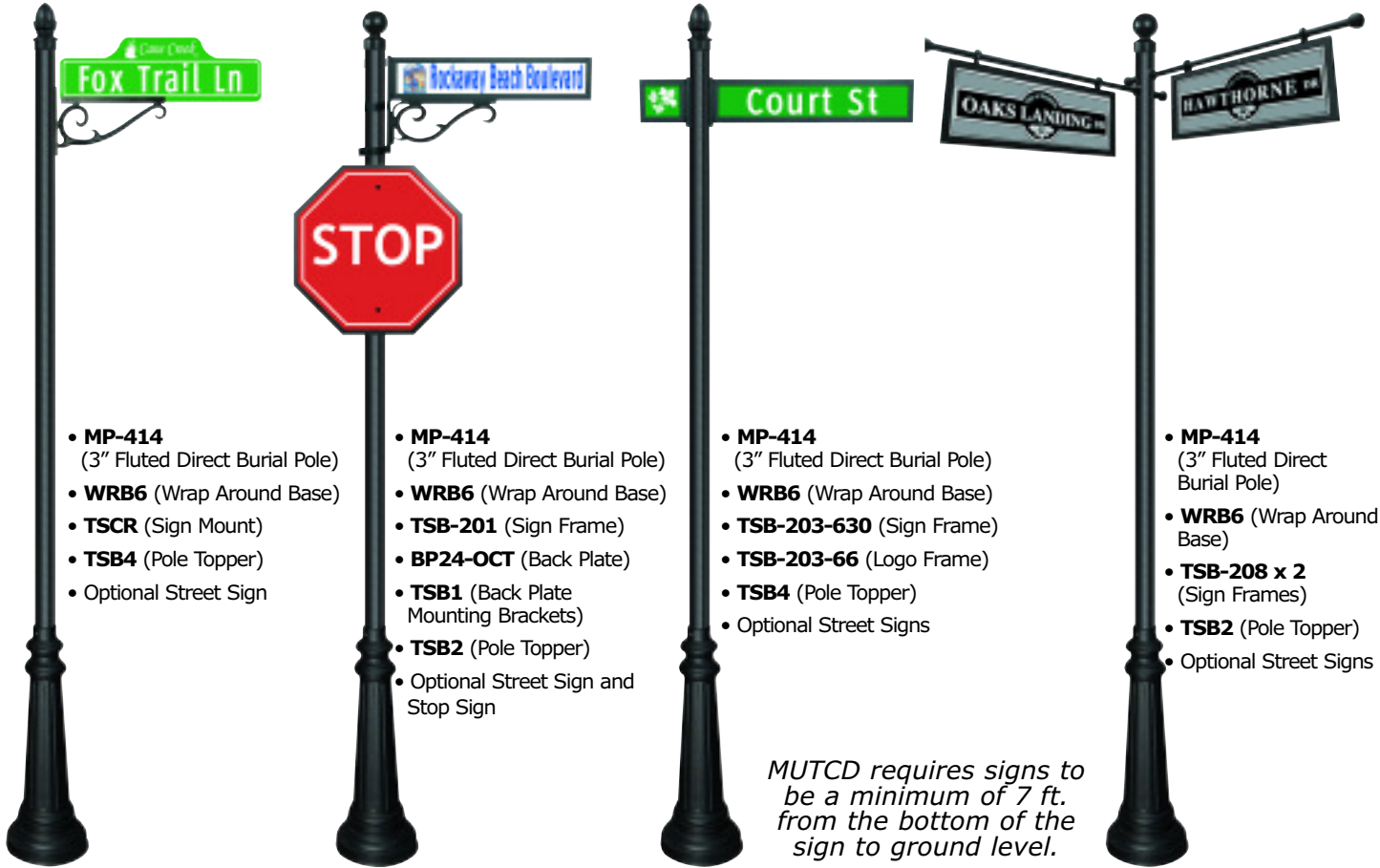

- **MP-414** (3" Fluted Direct Burial Pole)
- **WRB6** (Wrap Around Base)
- **TSR** (Sign Mount)
- **TSB4** (Pole Topper)
- Optional Street Sign

- **MP-414** (3" Fluted Direct Burial Pole)
- **WRB6** (Wrap Around Base)
- **TSB-201** (Sign Frame)
- **BP24-OCT** (Back Plate)
- **TSB1** (Back Plate Mounting Brackets)
- **TSB2** (Pole Topper)
- Optional Street Sign and Stop Sign

- **MP-414** (3" Fluted Direct Burial Pole)
- **WRB6** (Wrap Around Base)
- **TSB-203-630** (Sign Frame)
- **TSB-203-66** (Logo Frame)
- **TSB4** (Pole Topper)
- Optional Street Signs

- **MP-414** (3" Fluted Direct Burial Pole)
- **WRB6** (Wrap Around Base)
- **TSB-208 x 2** (Sign Frames)
- **TSB2** (Pole Topper)
- Optional Street Signs

MUTCD requires signs to be a minimum of 7 ft. from the bottom of the sign to ground level.

The Town Square Series pole and base combination is the industries most upscale traffic and lighting pole. The details of this combination puts it a step above the rest. (All components sold separately.)

- Available in 3" and 4" O/D Poles (see below)
- 8 ft., 10 ft., 12 ft., 14 ft. & 16 ft. lengths available
- Fully sculpted wrap around base
- Rust free extruded aluminum
- Maintenance free powder coated finish
- Coordinating cast aluminum lighting, mailboxes and posts available

Base Detail (32" H, 11 3/4" Dia.)



See page 31 for details about our U.S. Federal Highway Administration approved Breakaway Poles

Pole Options

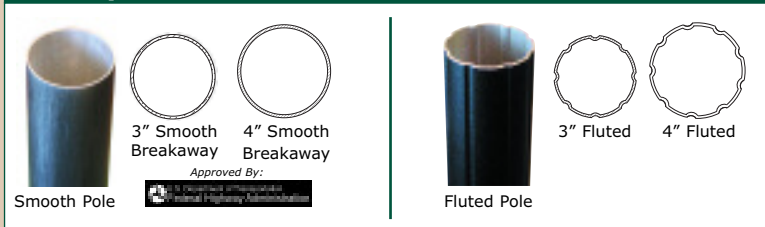

Burial Options

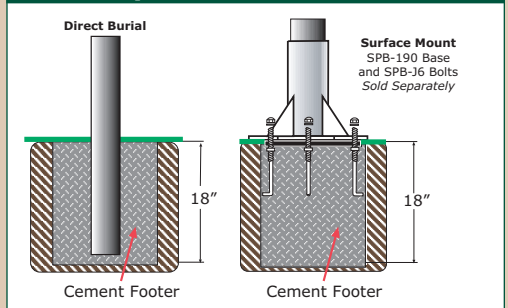



Breakaway Poles Available.
See page 31 for details.

3" O/D D.O.T. SIGN POLES

See page 52 - 55 for ordering information

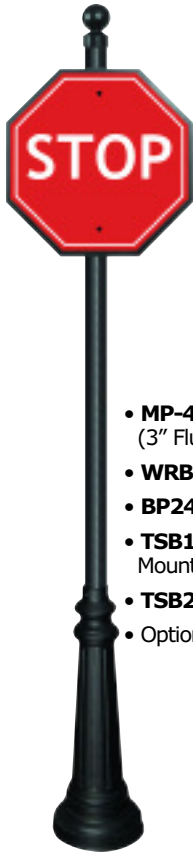

- **MP-414**
(3" Fluted Direct Burial Pole)
- **WRB6** (Wrap Around Base)
- **BP24-OCT** (Back Plate)
- **TSB1** (Back Plate Mounting Brackets)
- **TSB2** (Pole Topper)
- Optional D.O.T. Sign

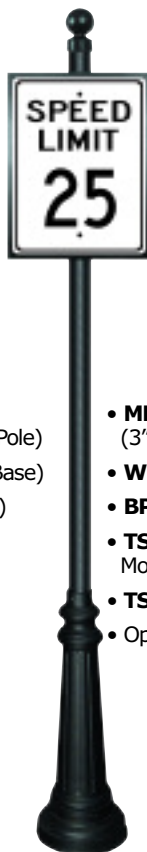

- **MP-414**
(3" Fluted Direct Burial Pole)
- **WRB6** (Wrap Around Base)
- **BP-1824** (Back Plate)
- **TSB1** (Back Plate Mounting Brackets)
- **TSB2** (Pole Topper)
- Optional D.O.T. Sign

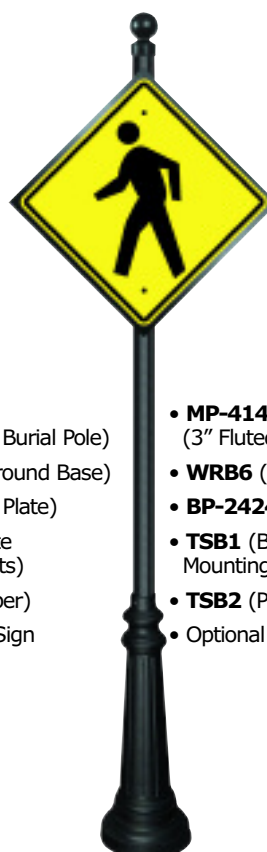

- **MP-414**
(3" Fluted Direct Burial Pole)
- **WRB6** (Wrap Around Base)
- **BP-2424** (Back Plate)
- **TSB1** (Back Plate Mounting Brackets)
- **TSB2** (Pole Topper)
- Optional D.O.T. Sign

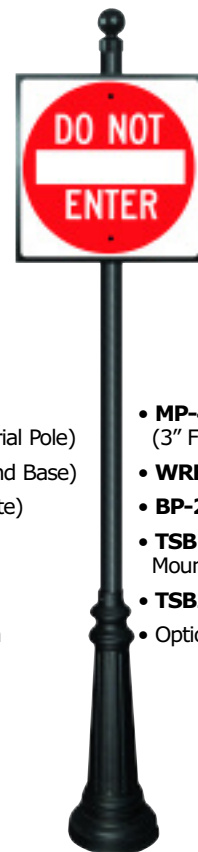

- **MP-414**
(3" Fluted Direct Burial Pole)
- **WRB6** (Wrap Around Base)
- **BP-2424** (Back Plate)
- **TSB1** (Back Plate Mounting Brackets)
- **TSB2** (Pole Topper)
- Optional D.O.T. Sign

WAYFINDING & INFORMATIONAL SIGNS

See page 32 - 35 for additional signage information



- **MP-408**
(3" Fluted Direct Burial Pole)
- **WRB6** (Wrap Around Base)
- **TSCR** (Sign Mount)
- **TSB14** (Sign Bracket)
- **TSB4** (Pole Topper)
- Optional Wayfinding Sign



- **MP-406 x 2**
(3" Fluted Direct Burial Poles)
- **WRB6 x 2** (Wrap Around Bases)
- **TSB14 x 8** (Sign Brackets)
- **TSB2 x 2** (Pole Toppers)
- Optional Wayfinding Signs

DECORATIVE RESIDENTIAL & COMMERCIAL LIGHTING

See pages 4 - 19 for additional lighting information



- **SMB1-12**
(Surface Mount Base with a 3" Fluted Pole)
 - **SMB-J12** (Anchor Bolts)
 - **F-3720** (Post Light)
- Incandescent and Compact Fluorescent light sources available.



- **SMB1-12**
(Surface Mount Base with a 3" Fluted Pole)
 - **SMB-J12** (Anchor Bolts)
 - **SHD1-PC2020CL**
(Fixture and Globe)
- H.I.D.** and **L.E.D.**
Light Sources Available



- **SMB1-12**
(Surface Mount Base with a 3" Fluted Pole)
 - **SMB-J12** (Anchor Bolts)
 - **SHD1-PC1023CL**
(Fixture and Globe)
 - **PFIN** (Finial)
- H.I.D.** and **L.E.D.**
Light Sources Available



- **SMB1-12**
(Surface Mount Base with a 3" Fluted Pole)
 - **SMB-J12** (Anchor Bolts)
 - **SHD1-PC1023CL**
(Fixture and Globe)
 - **SR** (Solid Roof)
 - **PFIN** (Finial)
- H.I.D.** and **L.E.D.**
Light Sources Available

CURBSIDE MAILBOX UNITS

See pages 56 - 59 for additional mailbox information



- **SPK-600**
(Surface Mount Mailbox Post)
- **STB-1007**
(Curbside Mailbox)



- **SPK-600**
(Surface Mount Mailbox Post)
- **SCB-1015-DX**
(Curbside Mailbox)



SPK-600 / SCC-2008 / BR2



MAIN STREET SERIES

4" SQUARE DECORATIVE TRAFFIC POLES

See page 52 - 55 for ordering information



- **MP-713**
(Square Direct Burial Fluted Pole)
- **TSB-202** (Sign Frame)
- **TSB11** (Pole Topper)
- Optional Street Sign



- **MP-713**
(Square Direct Burial Fluted Pole)
- **SF24-OCT** (Sign Frame)
- **TSB11** (Pole Topper)
- Optional Stop Sign

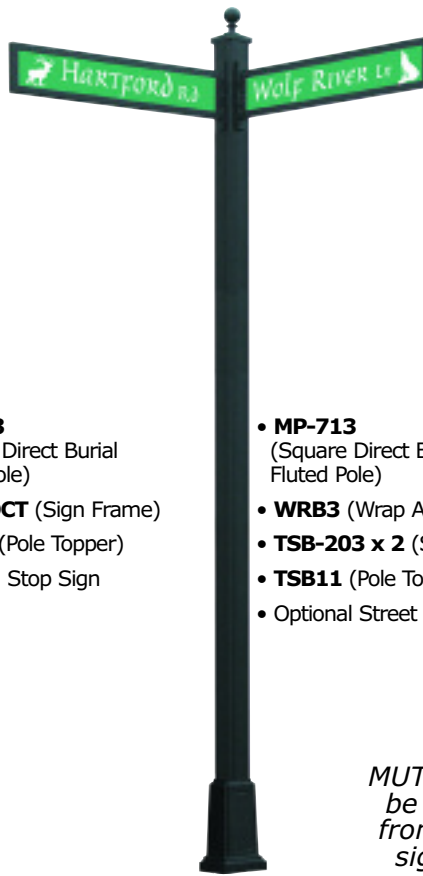

- **MP-713**
(Square Direct Burial Fluted Pole)
- **WRB3** (Wrap Around Base)
- **TSB-203 x 2** (Sign Frames)
- **TSB11** (Pole Topper)
- Optional Street Signs

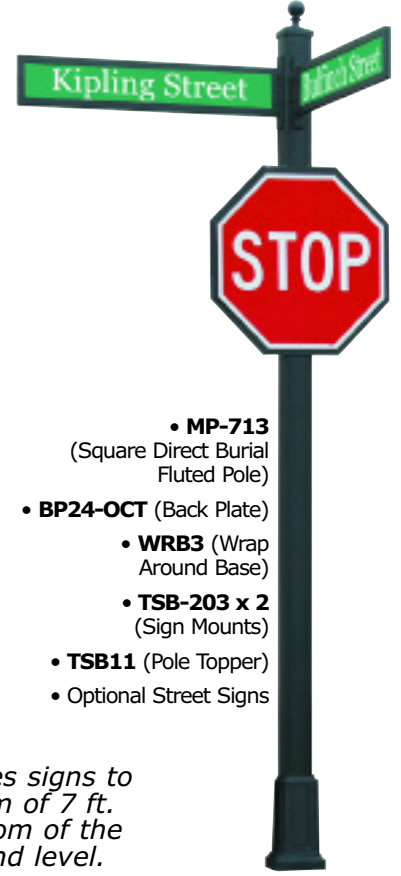

- **MP-713**
(Square Direct Burial Fluted Pole)
- **BP24-OCT** (Back Plate)
- **WRB3** (Wrap Around Base)
- **TSB-203 x 2** (Sign Mounts)
- **TSB11** (Pole Topper)
- Optional Street Signs

MUTCD requires signs to be a minimum of 7 ft. from the bottom of the sign to ground level.

The Main Street street sign pole is perfect for your custom street signage system and decorative street signs. This post's square design with sculpted corners and accent flutes gives the Main Street series a unique, contemporary look. (All components sold separately.)

- Elegant street sign pole
- 8 ft., 10 ft., 12 ft. & 13 ft. lengths available
- Sculpted base adds to appearance and value
- 4" x 4" Square Pole with sculpted corners
- Rust free extruded aluminum
- Maintenance free powder coated finish



Base Detail (14" H x 7" W)

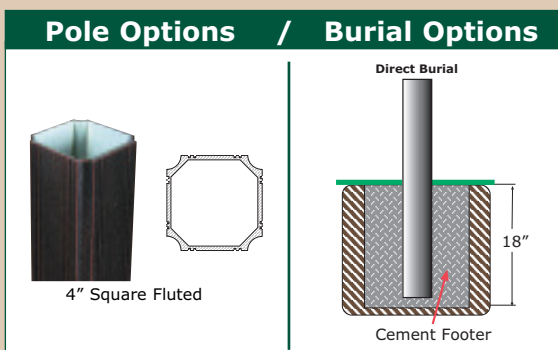
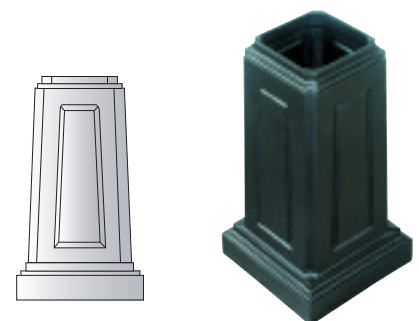

4" SQUARE D.O.T. SIGN POLES

See page 52 - 55 for ordering information

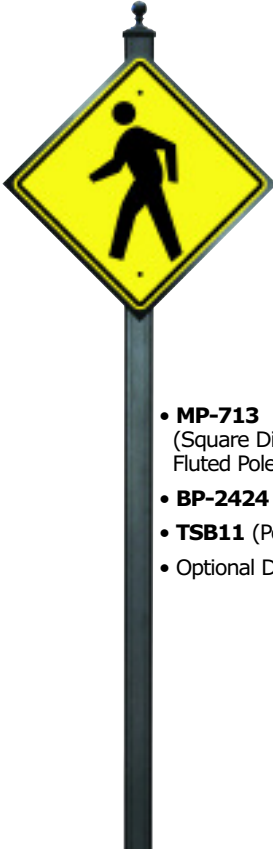

- **MP-713** (Square Direct Burial Fluted Pole)
- **BP-2424** (Back Plate)
- **TSB11** (Pole Topper)
- Optional D.O.T. Sign

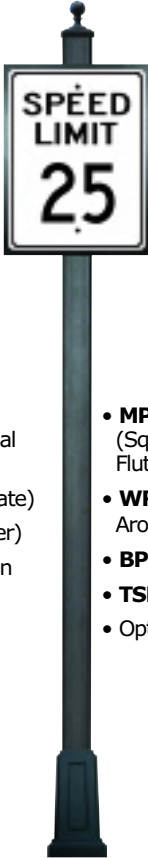

- **MP-713** (Square Direct Burial Fluted Pole)
- **WRB3** (Wrap Around Base)
- **BP-1824** (Back Plate)
- **TSB11** (Pole Topper)
- Optional D.O.T. Sign

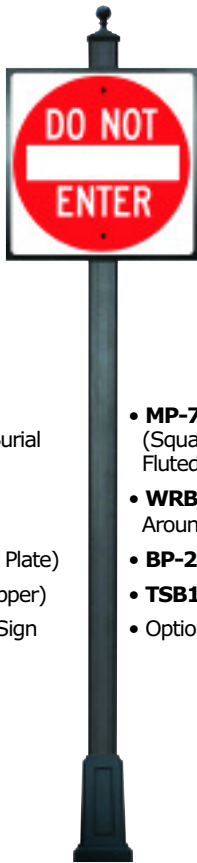

- **MP-713** (Square Direct Burial Fluted Pole)
- **WRB3** (Wrap Around Base)
- **BP-2424** (Back Plate)
- **TSB11** (Pole Topper)
- Optional D.O.T. Sign



- MP-713
- SF24-OCT
- TSB-202
- TSB11
- Optional Signage

CURBSIDE MAILBOX UNITS

See page 56 - 59 for additional mailbox information



- **SPK-700** (Direct Burial Mailbox Post)
- **SCB-1015-FN** (Curbside Mailbox with Front Numbers)



- **SPK-700-DBL** (Direct Burial Mailbox Post)
- **SCB-1015-FN x 2** (Two Curbside Mailboxes with Front Numbers)

WAYFINDING & INFORMATIONAL SIGNS

See page 32 - 35 for additional sign information



- **MP-710** (Square Pole Direct Burial Fluted Poles)
- **TSB-202-1824 x 2** (Sign Frames)
- **WRB3** (Wrap Around Base)
- **TSB11** (Pole Topper)
- Optional 18" x 24" Signs

HOW TO ORDER

Our Direct Burial Poles and accessories are made of Extruded Aluminum and Cast Aluminum and are available in your choice of 14 durable powder coated base finishes. Poles require a minimum of 18" of the pole be submerged into the concrete pad for proper installation. The end user must check the local codes and ordinances for minimum depth required for safe installation.

Ordering Example: BA-410 / WRB6 / TSB-201 / TSB2.

(3" x 10' Round Smooth Pole / Town Square Base / Single Sign Mount / Pole Topper)

STEP 1 - POLE TOPPERS

FOR 3" ROUND POLES



TSB2

3 1/2" W x 6" H



TSB4

3 7/8" W x 7 1/2" H



TSB5

3 3/4" W x 6 1/2" H



TSB7

3 1/2" W x 7" H



TSB10

4 1/2" W x 7 3/4" H

FOR 4" SQUARE POLE



TSB11

4 1/4" W x 5 1/4" H



TSB12

4 3/8" W x 1 3/4" H

STEP 2 - 3" ROUND / 4" SQUARE POLES

3" O/D Extruded Aluminum Poles.

(Break Away Poles Are Federal Highway Administration Approved).

	Over All Pole Length				
	8' Length	10' Length	12' Length	14' Length	16' Length
	Model # BA-408	Model # BA-410	Model # BA-412	Model # BA-414	Model # BA-416
	MP-408	MP-410	MP-412	MP-414	MP-416
	MP-708	MP-710	MP-712	13' Length MP-713	Not available at this time

Ask about custom pole topper options.

STEP 3 - BASES

BASES FOR 3" ROUND POLES



WRB1
Classic Series
Wrap Around Base
26" Height
7 1/2" Dia.



WRB2
Del Flora
Slip Over Base
26" Height
6 3/4" Dia.



WRB5
Country Lane Series
Wrap Around Base
24" Height
8" Dia.



WRB6
Town Square Series
Wrap Around Base
32" Height
11 3/4" Dia.



WRB7
Metro
Slip Over Base
4 3/16" Height
7" Dia.



WRB8
Americana
Wrap Around Base
10 1/4" Height
9 1/4" Dia.

BASE FOR 4" SQUARE POLE



WRB3
Main Street Series
Slip Over Base
14" Height
7" Width

STEP 4 - STREET SIGN MOUNTING

The TSB series of Street Sign Holders can be ordered to hold any size Sign Blade. Add the height and length of the Sign Blade in inches to the end of the item number of the desired sign. For example: for a 6" x 24" Sign Blade in a TSB201 bracket the item number would be TSB201-624. Length of the arm's bar will vary from the length of the Sign Blade. Sign Blades sold separately.

TSCR

Clamps around 3" O/D round poles.
Scroll: 16" W x 5 1/2" H.

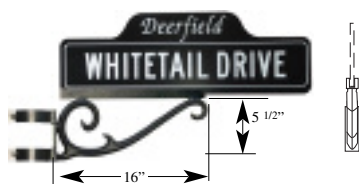

TSCR-700

Bolts to any Special Lite pole.
Scroll: 16" W x 5 1/2" H.



TSCR-DBL

Two TSCR brackets welded together at a 90° angle. Clamps around 3" O/D round poles. Scroll: 16" W x 5 1/2" H.



TSB-201

Clamps around 3" O/D round poles.
TSB-201-624: holds 6" x 24" sign.
Scroll: 16" W x 5 1/2" H.



TSB-201-DBL

Two TSB-201 brackets welded together at a 90° angle. Clamps around 3" O/D round poles. Scroll: 16" W x 5 1/2" H.



TSB-202

Bolts to any Special Lite pole.
TSB-202-624: holds 6" x 24" sign.
Scroll: 16" W x 5 1/2" H.



TSB-203-66 TSB-203-624

Bolts to any Special Lite pole.
Use model # TSB-203-624 to order without Logo Frame.



TSB-205

Clamps around 3" O/D round poles.
TSB-205-624: holds 6" x 24" sign.



TSB-205-DBL

Two TSB-205 brackets welded together at a 90° angle. Clamps around 3" O/D round poles.



TSB-206

Clamps around 3" O/D round poles.



TSB-207

Clamps around 3" O/D round poles.
Scroll: 16" W x 5 1/2" H.



TSB-208

For use with 3" O/D round poles
(shown mounted to smooth pole - sold separately.)



TSB-208-DBL

For use with 3" O/D round poles.
(shown mounted to smooth pole with TSB2 pole topper - both sold separately.)



TSB-209

For use with 3" O/D round poles.
(shown mounted to smooth pole with TSB2 pole topper - both sold separately.)



TSB-210

for use with 3" O/D round poles.
(shown mounted to smooth pole - sold separately.)



STEP 5 - POLE TOP MOUNTING BRACKETS & FINIALS

TSB3

Finial for flat street blade.
TSB3-X Extruded street blade finial.

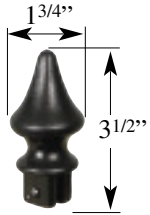

TSB8

Finial for flat street blade.
TSB8-X Extruded street blade finial.

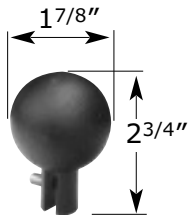

TRO

Fits 3" O/D round poles.
Holds one flat or extruded street blade.



DBL

Fits on top of flat street blade.
Holds one flat street blade. **DBL-X** holds extruded blades.



TSB15

4" to 3" pole Adapter.
Easily attach mounting brackets or light fitters to a 4" O/D pole.



SIGN MOUNTING BRACKETS & HARDWARE

TSB1 - For 3" O/D poles

TSB61 - For 4" O/D poles

Pole sign bracket / hardware (set of 2)



TSB9 - For 3" O/D poles

TSB62 - For 4" O/D poles

Sign bracket / hardware for back to back signage mount (set of 2)



TSB14 - For 3" O/D poles

TSB63 - For 4" O/D poles

Pole sign bracket / hardware (set of 2)



TSB14 & TSB63 Mounting Example

TSB13

Vandal proof nuts (pack of 10)

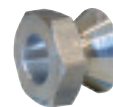

BP24-OCT mounted with TSB1 brackets



STEP 6 - TRAFFIC SIGN BACK PLATES

Measurements are for the Sign Blade going onto the backplate. Backplates have a 1" wide edge on all sides. The Traffic back plates are provided undrilled for custom mounting. To order a custom backplate use the item number BP followed by the height then the width of the sign.

For example: to order a Back Plate for a 24" x 30" sign the item number would be BP-2430.

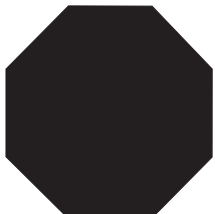

24" Back Plate BP24-OCT
30" Back Plate BP30-OCT



24" x 24" Back Plate BP-2424
30" x 30" Back Plate BP-3030



12" x 18" Back Plate BP-1218
18" x 24" Back Plate BP-1824

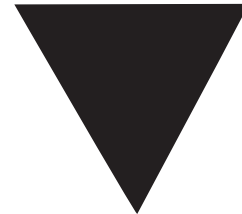

30" Back Plate BP30-TRI
36" Back Plate BP36-TRI
measurement is point to point

TRAFFIC SIGN FRAMES

Measurements are for the Sign Blade going into the frame. Sign Frames have a 1" square edge on all sides. To order a custom Sign Frame, use the item number SF followed by the height then the width of the sign. For example: to order a Frame for a 18" x 24" sign the item number would be SF-1824.



24" Frame SF24-OCT
30" Frame SF30-OCT



24" x 24" Frame SF-2424
30" x 30" Frame SF-3030



12" x 18" Frame SF-1218
18" x 24" Frame SF-1824



30" Frame SF30-TRI
36" Frame SF36-TRI
measurement is point to point

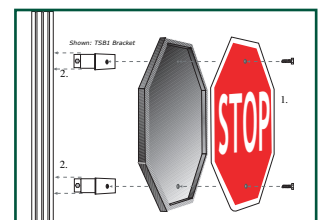

Sign Frame or Back Plate mounting diagram

Street name and regulatory signs must conform to the Manual on Uniform Traffic Control Devices (MUTCD). Always check with your local ordinance or municipality to ensure size and reflective requirements are met or exceeded when purchasing traffic control signage.

STEP 7 - STREET NAME SIGNS

- Sign blades available in flat or extruded aluminum
- When the speed limit is 25 mph or less, use a minimum 6" high sign with 4" high letters
- When the speed limit is over 25 mph, use a minimum 9" high sign with 6" high letters
- MUTCD requires the use of capital & lower case letters (ex: Main Street)
- Signs need to have a reflective background sheeting (minimum of Engineer Grade Prismatic, High Intensity Prismatic is recommended)
- ** High Intensity Prismatic will be required choice within the next few years.



Flat Aluminum Blade

6" High Blade

By necessary length



9" High Blade

By necessary length



Extruded Aluminum Blade

6" High Blade

By necessary length



9" High Blade

By necessary length



CUSTOM STREET SIGNS

- Special Lite Products can customize any basic street sign to provide a unique look or custom cut metal blades to create logos and other designs to make your signs stand out from the rest.



STEP 8 - D.O.T. REGULATORY AND INFORMATIONAL SIGNS

- Special Lite Products can provide you with all your regulatory sign needs.
- Signs available in Engineer Grade, High Intensity Prismatic and Diamond Grade Prismatic. (when applicable)

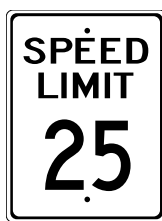

MUTCD requires sign to be mounted 7 ft. from the bottom of sign to ground level.

7 ft.

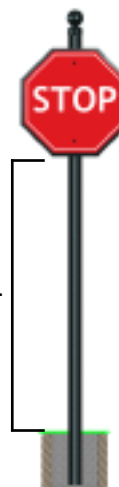

CURBSIDE MAILBOX UNITS

Our Curbside Mailboxes and Posts will provide years of beauty and charm to any residential or commercial development. Our mailboxes are made of cast aluminum and have a durable powder coated finish. **(See our Mailbox Catalog for our full line of mailboxes, posts and accessories.)**



- **SPK-600** (Surface Mount Mailbox Post)
- **SCS-1014** (Savannah Curbside Mailbox)
- *Shown in Copper (CP)*

** Mailbox available with Paper Tube
Model #: SCS-2014

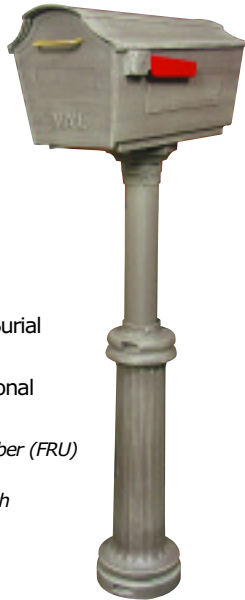

- **SPK-590** (Direct Burial Mailbox Post)
- **STB-1007** (Traditional Curbside Mailbox)
- *Shown in Frosted Umber (FRU)*

** Mailbox available with Paper Tube
Model #: STB-2007



- **SPK-679** (Direct Burial Mailbox Post)
- **SCB-1015** (Berkshire Curbside Mailbox)
- *Shown in Black (BL)*

** Mailbox available with Paper Tube
Model #: SCB-2015



- SPK-591
- SCB-1005
- MP-453
- *Shown in Hand Rubbed Bronze (BR)*



- SPK-600-DBL
- SCB-2015-FN x 2
- *Shown in Copper (CP)*

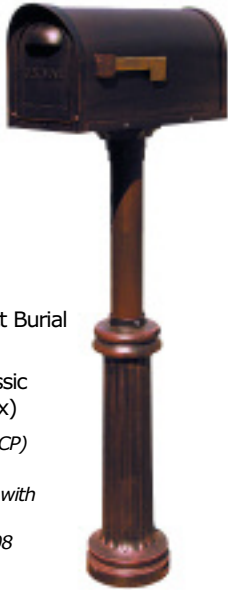

- **SPK-590** (Direct Burial Mailbox Post)
- **SCC-1008** (Classic Curbside Mailbox)
- Shown in Copper (CP)

** Mailbox available with Paper Tube
Model #: SCC-2008



- **SPK-591** (Surface Mount Mailbox Post)
- **SCT-1011** (Boulevard Curbside Mailbox)
- Shown in Hand Rubbed Bronze (BR)

** Mailbox available with Paper Tube
Model #: SCT-2011



- **SPK-600** (Surface Mount Mailbox Post)
- **SCF-1003** (Floral Curbside Mailbox)
- **MP-453** (Address Plaque)
- Shown in Verde Green (VG)

** Mailbox available with Paper Tube
Model #: SCF-2003



- 450
- SCF-1003
- Shown in Verde Green (VG)



- SPK-700
- SCB-1015-FN
- Shown in Black (BL)

GANGBOX UNITS

Enhance the curb appeal of your community or development and make a good first impression with a gang box configuration comprised of our decorative posts and curbside mailboxes. Gangbox units can be created from many of our decorative curbside mailboxes and posts. Call Special Lite Products today to learn more about our gangbox combinations.



- **SPK-591-TRI** (Surface Mount Mailbox Post)
- **STB-1007** (Three Town Square Curbside Mailboxes)
- *Shown in Black (BL)*

** Mailboxes available with Paper Tube
Model #: STB-2007



- **SPK-591 QUAD** (Surface Mount Mailbox Posts)
- **SCS-1014** (Four Savannah Curbside Mailboxes)
- *Shown in Black (BL)*

** Mailboxes available with Paper Tube
Model #: SCS-2014



- **SPK-592-TRI**
- **SCC-2008 x 3**
- **BR2**
- *Shown in Black (BL)*



- **SPK-591-QUAD**
- **SCB-2015-FN X 4**
- *Shown in Black (BL)*



- **SPK-592-QUAD**
- **SCC-2008 x 4**
- **BR2**
- *Shown in Black (BL)*

CURBSIDE MAILBOX ACCESSORIES

LOCKING INSERTS

Protect yourself from identity theft with our locking inserts.

- Parcels up to the size of a VHS tape can pass through the slot into the safety of the locking insert, while magazines and catalogs rest on the top of the locking insert.
- An angled tab inside the slot prohibits anyone from reaching in and removing the mail.



LB-998

6 3/4" W x 4 3/4" H x 18" D
Fits in SCB-1015, SCF-1003,
SCB-1005, and SCC-1008
Curbside Mailboxes



LB-997

9 1/4" W x 6" H x 17 1/4" D
Fits in STB-1007 Town Square
Curbside Mailbox



The locking inserts firmly attaches to the bottom of the mailbox and cannot be removed without the key.

TOP MOUNTING ADDRESS PLAQUES

- Our top mounting address plaques easily attaches to the top of your mailbox and will serve to clearly mark your box for delivery and help emergency personnel find your home. Plaque accommodates up to five of our 2" numbers. (*Numbers sold separately*)



MP-452 Contemporary

14 1/2" W x 3 1/2" H
6 1/2" W x 2" numbering area
*Shown in
Hand Rubbed Bronze (BR)*



MP-453 Art Nuevo

15 1/2" W x 3 1/2" H
6 1/2" W x 2" numbering area
Shown in Swedish Silver (SW)



SIDE MOUNTING ADDRESS PLAQUE

- Add a sophisticated look to our Berkshire, Boulevard or Classic curbside mailboxes. The 12" W x 4" H screw on panels have a rich leather texture with a beveled edge and accommodates up to five of our 3" numbers. A complete mounting kit is included. (*Numbers sold separately*)

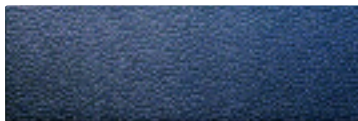

MP-454
12" W x 4" H
Set of two.

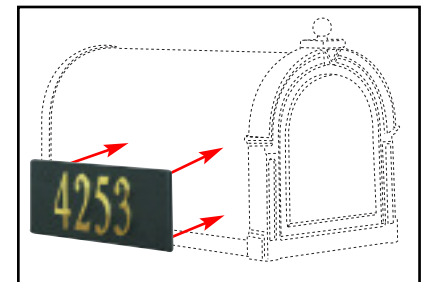

ADDRESS NUMBERS

- Self adhesive address numbers are available in your choice of Stainless Steel and Polished Brass finish. To order, simply put your address after our item number to indicate the size of numbers you want.

For example: If you want 2" Polished Brass numbers for address 1302, the item number you would use is BR2-1302.

1 2 3 4 5 6 7 8 9 0

Stainless Steel

Polished Brass

SS2 - Two Inch Stainless Steel Numbers
BR2 - Two Inch Polished Brass Numbers
SS3 - Three Inch Stainless Steel Numbers
BR3 - Three Inch Polished Brass Numbers

ADDRESS PLAQUES

LIGHTED ADDRESS PLAQUES

Give your home the mark of distinction with a bright and durable Lighted Address Plaque. Visible at over 100 feet away, these Low Voltage Address Plaques are made from Cast Aluminum or Rigid Polymer. These Plaques can be wired directly to your door bell transformer or plugged directly into a wall outlet with the optional Wall Outlet Transformer. Ten feet of Low Voltage wire is included with the Plaques. Choose up to five 4 inch black numbers per Lighted Address Plaque at the time of order. Cast Aluminum Address Plaque frames available in all Special Lite finishes.



Kingsport SAP-4210

14 1/2" W x 10 3/8" H
Cast Aluminum Frame. Available in all finishes with White Background.



Manor SAP-4220

13 7/8" W x 8 7/8" H
Cast Aluminum Frame. Available in all finishes with White Background.



Replacement Door Bell Transformer
DBT-4200



Wall Outlet Transformer
WOT-4200

Manor SAP-4230

13 7/8" W x 8 7/8" H
High Impact Polymer Frame
Black Finish with White Background Only.

CAST ALUMINUM ADDRESS PLAQUES

Our line of Cast Aluminum Address Plaques help you mark your home with a unique style. Solid cast aluminum and powder coated to withstand the elements, these beautiful plaques coordinate with our mailboxes and outdoor lighting fixtures. (Up to five 3" numbers in your choice of Polished Brass or Stainless Steel; specified at time of order.)



Colonial SAP-4170

12" W x 7 1/4" H
Available in all finishes with Black Background.



Traditional SAP-4140

11 1/2" W x 6" H
Available in all finishes with Black Background.



Boulevard SAP-4190

16 1/2" W x 11" H
Available in Black, Mocha or any of our Antique Finishes with Black Background.



Floral SAP-4110

12 3/4" W x 9 1/2" H
Available in all finishes with White Background.



Classic SAP-4180

14 1/4" W x 10 1/2" H
Available in all finishes with White Background.

CLUSTER BOX UNITS

The Florence vital™ 1570 series cluster box unit design has been adopted by the USPS as the design standard for all CBUs manufactured in the United States. We are pleased to offer a complete line of USPS approved cluster box units to fit your individual project needs. We are proud to offer you the security and reliability that the USPS depends on every day.

Standard Features:

- Robotically welded cabinet and hood seams
- Rugged, weather resistant powder coat finish resists scratching and vandalism
- Constructed of 300 series stainless steel and aircraft aluminum, including aluminum pedestal
- Master front loading door designed to prevent prying with interlocking overlap seams
- Solid aluminum mail slot frame that protects adjacent customer compartment and collection compartment
- Silver adhesive metal placards with black numbers 1-16 and 1P-2P



1570-8SDAF
8 COMPARTMENT CBU



1570-12SDAF
12 COMPARTMENT CBU



1570-13SDAF
13 COMPARTMENT CBU



1570-16SDAF
16 COMPARTMENT CBU

DECORATIVE CBU ACCESSORIES

Looking for a way to turn your standard CBU into something more “upscale”? We have many attractive accessories available. Please contact us on pricing for your specific model.



FINISH OPTIONS

Solid Finish Choices - (available on all fixtures, posts, mailboxes & accessories)



BL Black



CHP Champagne



GM Gunmetal



BG Burgundy



EG Evergreen



MOC Mocha

TB
Textured
Beige



WH
White

Antiqued Finish Choices - (available on all fixtures, posts, mailboxes & accessories)



BR Hand Rubbed Bronze



FRU Frosted Umber



VG Verde Green



CP Copper



SW Swedish Silver



WG White and Gold

Custom finishes are available for a nominal charge. Please contact us for pricing & availability.





Delivering Quality Every Day

**Custom Home Accessories, Inc.
11300 Trade Center Drive, Ste. A
Rancho Cordova, CA 95742 USA**

**1-800-265-0041 Toll free
1-916-635-0231 Local
1-916-635-0228 Fax
www.customhomex.com**