

MODEL NO.

0840 0841
0842 0843
0844 0845
0846 0847
0848 0849



AGES 3+

SHELBY COBRA 427S/C®

12V BATTERY OPERATED RIDE ON

OWNER'S MANUAL

Please read entire manual before starting assembly.
Keep this manual along with your purchase receipt
for future reference.



 **CAUTION**
Screws contain potentially hazardous sharp points or sharp edges. Adult assembly required

 **WARNING**
Toy must be assembled by adult before use

 **WARNING**
CHOKING HAZARD-Small parts
Not for children under 3 years

 **WARNING**
To reduce the risk of injury, adult supervision is required. Never use on road ways, near motor vehicles, on or near steep inclines or steps, swimming pools or other bodies of water. Always wear shoes, and never allow more than one rider.



©National Products Ltd.
Room 413-415, Houston Centre,
63 Mody Road, Tsim Sha Tsui East,
Kowloon, Hong Kong.
1-877-743-3899
WWW.NPL2.COM
INFO@NPL2.COM

SHELBY®, 427 S/C®, THE SHAPE AND DESIGN (TRADE DRESS) OF THE SHELBY COBRA 427 S/C VEHICLE™ ARE REGISTERED TRADEMARKS AND/OR THE TRADE DRESS OF CARROLL SHELBY AND CARROLL SHELBY LICENSING, INC. (SHELBY). COBRA AND THE COBRA SNAKE DESIGNS ARE TRADEMARKS OF FORD MOTOR COMPANY USED UNDER LICENSE.

Contents, colors and decorations may vary from those shown.

IMPORTANT

You must charge your battery for 18 hours before you use your vehicle for the first time.

Remember to. . .

- ✓ Charge the battery immediately after each use.
- ✓ Charge the battery at least once a month during storage, even if the vehicle has not been used.

The battery will be permanently damaged and void your warranty if you fail to follow the instructions. Please refer to the Battery Care Section in this manual for more information.

LIMITED WARRANTY

(The warranty and toll free number only apply in the United States and Canada)

This vehicle is warranted by NPL[®] for ninety days from date of purchase against defects in materials or workmanship. The warranty covers the NPL[®] vehicle which has been used under normal circumstances, solely for the purpose for which it was intended and has been given proper care and maintenance. The warranty does not cover damage caused by the customer, damage which results from normal wear and tear or from alterations made by the customer, or damage caused by use for an unintended purpose. Shipping and handling are not covered by this warranty.

Please keep the original purchase receipt for any warranty claims, and inspect the product upon purchase for any defects or missing parts.

We are here to help -

- For parts order, please visit: www.funcreation.net
- For Customer Service, please email us: customerservice@funcreation.net
- Or call our number: 1-909-594-4000 / 1-877-743-3899

Table of Contents

Limited Warranty	2
Important Information	3
Warning	4
Battery Warning	5
Battery Charging	6
Battery Care and Disposal	7
Parts List	8
Assembly	9-13
Operating Your Vehicle	14
Trouble shooting	15-17
Applying Decals	18
Parts Diagram	19

3

Important Information

Important Information

- Your new vehicle requires adult assembly. Please set aside at least 30 minutes for assembly.
- You must charge your battery for 18 hours before you use your vehicle for the first time. **We recommend that you start charging your battery before beginning assembly.** Please see Battery charging beginning on page 6 for detailed instructions.
- Read this manual carefully for important safety information and operating instructions before using your vehicle. Keep these instructions for future reference as they contain important information.
- Do not operate on grass.
- This vehicle is designed for use on: concrete, asphalt or other hard surfaces; on generally level terrain; by children ages 3 and up.
- Instruct the children on operation and safe driving rules before they take their first drive:
 - always sit in the seat.
 - always wear shoes.
 - only one (1) rider at a time.
 - Do not place hands, feet or any part of the body, clothing or other articles near moving parts while the vehicle is in operation.
 - Do not allow other children near the car when driving.
- Use this vehicle **ONLY** outdoors. Most interior flooring can be damaged by riding this vehicle indoors.
- NPL® will not be responsible for damage to the floor if the vehicle is used indoors.
- To prevent damaging the motors and gears, do not tow anything behind the vehicle or overload it. Do not exceed the maximum weight capacity of 66 lbs. (30 kg).
- If you have any questions about your NPL® vehicle, please call our service lines at 1-909-594-4000 / 1-877-743-3899 from 9 AM to 5 PM (PST) Monday through Friday. Trained customer service representatives are available to take your call.
- The NPL® service centers will repair or replace parts under warranty at no extra charge, and can perform non-warranty repairs for a minimal charge. (The warranty and customer service contact in this manual only apply in the United States and Canada)

Warning

To Prevent Serious Injuries

- This product is intended for use by children ages 3 and up, and is not intended for children under 3 years of age due to lack of ability to operate safely.
- Maximum weight 66 lbs.(30 kg). Only 1 rider at a time.
- Do not leave children unattended. Adult supervision required.
- This package contains small parts. Keep away from the children until assembled.
- Read manual for detailed safety information prior to use.
- Inspected product at regular intervals for wear or loose hardware and tighten as required. Remove from service if any abnormal conditions such as cracks or breaks exist.
- Check all coverings regularly to make sure they are in place.
- Batteries can fall out and injure a child if the vehicle tips over. Always use the battery cover.
- When the temperature falls below 0°F(-18°C), outdoor use this product is not recommended.
- In extreme cold, plastic materials might lose resilience and may become brittle and crack upon impact. Store in a warmer and protected place.
- Do not operate the vehicle outdoors if it is raining. Keep it in a dry area when not in use.
- Disconnect the battery power supply when the vehicle is not in use to prevent the children driving the car without adult supervision.
- Always make sure the seat is securely attached.
- Only use the charger specified by NPL®.
- The charger and battery are not toys and must be regularly examined for damage to the cord, plug, enclosure and other parts.
In the event of damage, the damage or worn part must not be used until replaced.
- Never modify the electrical system. Using the wrong type battery or charger could cause a fire or explosion.
- The battery compartment and area under seat are not storage areas. Storing other articles may create a fire hazard. Do not store any articles in or near motor compartment.

Safe Driving Rules

• **ADULT SUPERVISION REQUIRED. MAKE SURE CHILDREN KNOW AND FOLLOW THESE RULES FOR SAFE DRIVING.**

- Restrict children to safe riding areas:
 - Away from swimming pools and other bodies of water to prevent drowning.
 - Level ground to prevent tipovers and unintended downhill motion.
 - Away from steps, hills, driveways, roads and alleys.
- Teach and learn the safety first:
Although most children can master the physical driving skills to control the vehicles, they do not have the mature judgment skills. Never let a child drive at any time without adult supervision, and take the time to carefully evaluate child's skill levels and abilities to operate the vehicle safely. Children can not always recognize the hazards even after instruction. So teach appropriate safety rules before allowing any child to operate vehicle, and remember that **THERE IS NO SAFE SUBSTITUTE FOR DIRECT ADULT SUPERVISION.**
- **Riding rules :**
 - Always sit on the seat and wear shoes.
 - Only one rider at a time.
 - Do not operate in the street or near moving vehicles.
 - Do not operate near bodies of water, obstructions or drop-offs.
 - Do not operate on sand, dirt or gravel.
 - Do not operate in the dark. Unexpected obstacles could cause an accident.
 - Do not operate on inclines or steep slopes.
 - Do not operate near flammable vapors (e.g. gasoline, paint thinner, acetone, liquid wax, etc.) Using the vehicle near flammable liquids can or vapors could cause an explosion or fire.
 - Do not place anything near moving parts such as motors, gears or wheels. Rotating parts can snag hair, fingers, etc., cause serious injury.

4

Warning

Battery Warning

5

Battery Warning

ELECTRICAL HAZARD



WARNING

Battery can fall out and injure a child if vehicle tips over. Always use battery cover.

PREVENT FIRE

- Never modify the electrical system. Alterations could cause a fire resulting in serious injury and could also ruin the electrical system.
 - Use of the wrong type battery or charger could cause a fire or explosion resulting in serious injury.
 - Use of NPL® components in products other than NPL® vehicles could cause overheating, fire or explosion.
- The battery must be handled by adults only. The battery is heavy and contains sulfuric acid (electrolyte). Dropping the battery could result in serious injury.
 - Never allow children to charge the battery.
 - Battery charging must be done by adults only. A child could be injured by the electricity involved in charging the battery.
 - Never lift or carry the battery by the wires or connector. This can damage the battery and possibly cause a fire resulting in serious injury. Lift and carry the battery by the case only.
 - Read the safety instructions on the battery.
 - Examine the battery, charger and their connectors for excessive wear or damage each time you charge the battery. If damage or excessive wear is detected, do not use the charger or the battery until you have replaced the worn or damaged part.



CAUTION

Only use the battery specified by NPL®.
Only use the charger specified by NPL®.
Only use the charger in dry locations.

About Thermal Fuses

- Your NPL® 12 volt battery is equipped with a built-in thermal fuse. The thermal fuse is a self-resetting safety device which automatically trips and shuts down operation of the vehicle if the vehicle is overloaded or the driving conditions too severe. Once a fuse has tripped it will automatically reset itself after approximately 10 seconds and allow the vehicle to resume normal operations. To avoid repeated automatic shut downs, do not overload the vehicle by exceeding the 66 lbs.(30 kg) maximum weight capacity or by towing anything behind the vehicle. Avoid severe driving conditions, such as driving up very steep slopes or running into fixed objects, which can cause the wheels to stop spinning while power is still being supplied to the motors.
- If a thermal fuse in a battery continually trips under normal driving conditions, please contact NPL® Service Center at 1-909-594-4000 / 1-877-743-3899.

Important Notes

- Your new battery must be charged for at least 18 hours before you use it in your vehicle for the first time.
- You do not need to remove the battery from your vehicle to recharge it.
- The battery must be upright while charging.
- The charger is not a toy.
- Do not short circuit the battery.
- We recommend that you start charging your battery before beginning assembly of your new vehicle.
- Before charging the battery, examine the battery case for cracks and other damage which may cause sulfuric acid (electrolyte) to leak during the charging process.
- If damage is detected, do not charge the battery or use it in your vehicle. Battery acid is very corrosive and can cause severe damage to surfaces it contacts.
- Do not charge the battery on a surface which could be damaged by the acid contained inside the battery. Take precautions to protect the surface on which you charge your battery.
- If your battery is old and will not accept a charge, do not leave it in the vehicle. Always remove a dead battery from the vehicle.
- Non-rechargeable batteries are not to be recharged.
- Rechargeable batteries are only to be charged under adult supervision.
- Only batteries of the same or equivalent type as recommended are to be used.
- Batteries are to be inserted with the correct polarity.
- Exhausted batteries are to be removed from the toy.
- The supply terminals are not to be short-circuited.

Battery Charging



CAUTION

- Non-rechargeable batteries are not to be recharged.
- Make sure the charger connector is matching with the battery connector.
- Make sure the brand, voltage and frequency of the charger are in accordance with the wall outlet.
- Batteries are to be inserted with the correct polarity.
- The supply terminals are not to be short circuited.

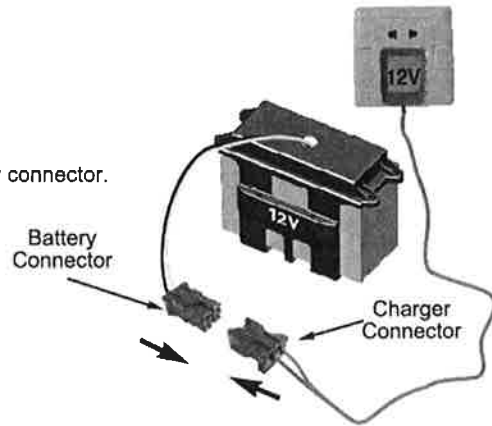

- Plug the battery connector into the charger connector.
- Plug the charger into a standard wall outlet.
- Use only the NPL®12 volt charger to charge your NPL®12 volt battery.
- Note: if power flow to the wall outlet is controlled by a switch, make sure the switch is "ON".
- Before first-time use, charge the battery for at least 18 hours. Never charge the battery longer than 24 hours.
- Recharge the battery for at least 12 hours after each use of your vehicle.
- Do not charge the battery longer than 24 hours.
- Do not charge or store battery upside down. Charging produces explosive gasses. Charge away from flames, sparks and lit cigarettes. Charge in a well ventilated area.
- Once the battery is charged, disconnect the battery connector from the charger connector. Unplug the charger from the wall outlet. The battery is now ready to be installed in your vehicle. Please see the following Battery Installation Section for detailed instructions on installing your vehicle:

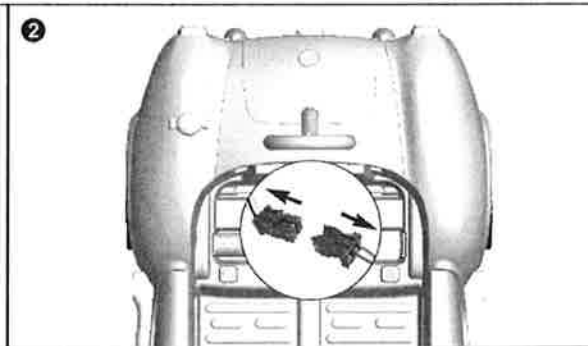
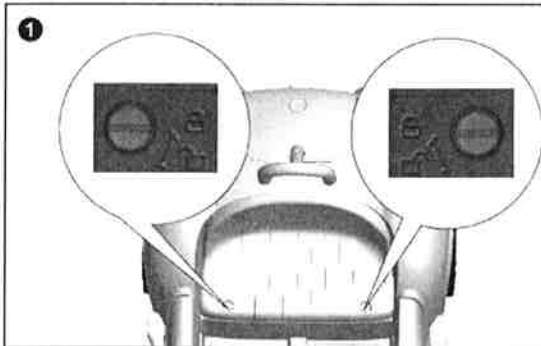

1 To unlock the seat, twist both screws from horizontal to upright position.

2 Disconnect the battery from vehicle.

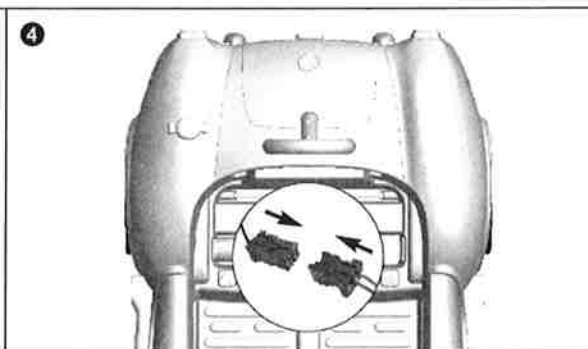
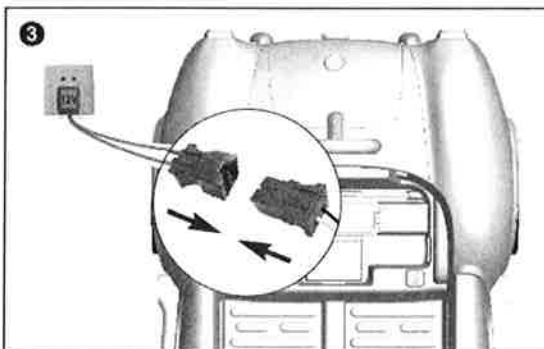

3 Connect the charger with battery.

4 Reconnect the battery with vehicle after it is fully charged.

Battery Care and Disposal

7

Battery Care and Disposal

Care

- If a **battery leak** develops, avoid contact with the leaking acid and place the damaged battery in a plastics sealed bag.
- If acid comes in **contact with skin or eyes**, flush with cool water for at least 15 minutes and call a physician immediately.
- If acid is **Internally Ingested**, give water, milk of magnesia or egg whites immediately. Never give emetics or induce vomiting. Call a physician immediately.
- Charge a new battery for at least 18 hours before first use.
- Never charge the battery longer than 24 hours.
- Overcharging or undercharging the battery may shorten battery life and decrease vehicle running time.
- After the first charge, recharge the battery for at least 12 hours after each use. Never charge the battery longer than 24 hours. Charge the battery after each use, regardless of how long the vehicle was used.
- The battery must be upright while charging.
- Do not allow the battery to run down completely before charging.
- Charge the battery before storing the vehicle.
- Charge the battery at least once per month, even if the vehicle has not been used.
- Leaving the battery in a discharged condition will ruin it.
- If the vehicle will be stored for more than two months, be sure to disconnect the motor harness from the battery.
- Do not store the battery in temperatures above 75° F or below -10° F.
- **Only use the 12 Volt battery specified by NPL®.**
- Prevent the battery from moving freely inside the battery compartment. Make sure all screws for battery cover tighten.
- Examine the battery, charger and its connector for excessive wear or damage each time you charge the battery. If damage is detected, do not use the charger or the battery until you have replaced the worn or damaged part.
- Remember to remove an exhausted battery from the vehicle.
- Battery leakage and corrosion can damage the vehicle.

Disposal











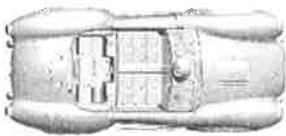



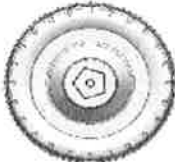

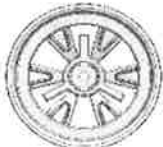
- Your NPL® battery is a sealed lead-acid battery. It must be recycled or disposed of it in an environmentally sound manner.
- Never dispose your battery in the regular, household trash. The incineration, landfilling or mixing of sealed lead-acid batteries with household trash is prohibited by law in most areas.
- To get a replacement battery, please visit your local retailer or contact at 1-909-594-4000 / 1-877-743-3899.
- Always remove exhausted batteries from your toy.
- Dispose of dead batteries properly, Never burn or bury them.
- Do not dispose of a lead-acid battery in a fire. The battery may explode or leak.
- Return exhausted batteries to a federal or state approved lead-acid battery recycler, such as a NPL® authorized service center, or a local seller of automotive batteries.
- For the service center, please call at 1-909-594-4000 / 1-877-743-3899.
Contact your local waste management officials for other information regarding the environmentally sound collection, recycling and disposal of lead-acid batteries. If you live in the State of Florida or Minnesota, it is prohibited by law for anyone to throw away lead-acid batteries in the municipal waste stream.
(The warranty and customer service contact in this manual only apply in the United States and Canada.)



TO PROLONG BATTERY LIFE, YOU MUST RECHARGE THE BATTERY AFTER EACH USE. YOU MUST ALSO CHARGE YOUR BATTERY IF IT HAS NOT BEEN USED FOR 30 DAYS OR MORE.

Parts List



- Please identify all parts before assembly and save all packaging material until assembly is completed to ensure that no parts are discarded.
- Metal parts have been coated with lubricant to protect them during shipment. Wipe all metal parts with a paper towel to remove any excess lubricant.

			
Car Body x 1	Steering Wheel x 1	Windshield x 1	Seat x 1
			
Rear Drive Wheel x 2	Front Wheel x 2	Hubcap x 4	Roll Bar x 1
			
Locknut Cap x 4	Washer x 6	Large Locknut x 4	Manual x 1
			
Screw x 1	Small Locknut x 1	Charger x 1	
(For Steering Wheel)			

Tools needed:

	
Screwdriver (Not included)	Locknut tool x 2 (Included)

Spare parts:

	
Locknut x 2	Washer x 2

Assembly



WARNING

Children can be harmed by small parts, sharp edges and sharp points in the vehicles unassembled state, or by electrical items. Care should be taken in unpacking and assembling the vehicle. Children should not handle parts, including the battery, or help in the assembly of the vehicle.

9

Assembly I

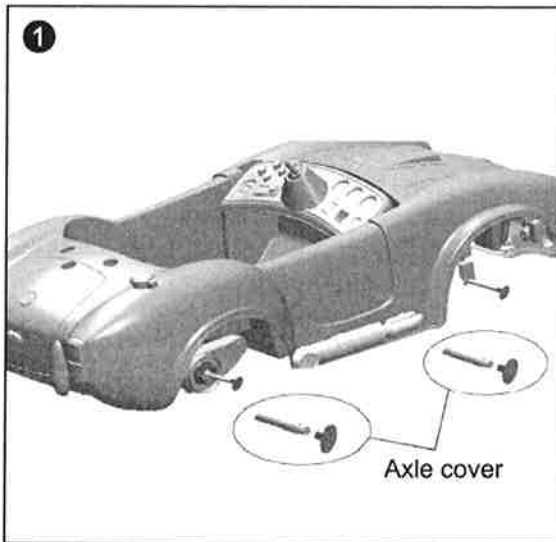

- Remove the axle covers.

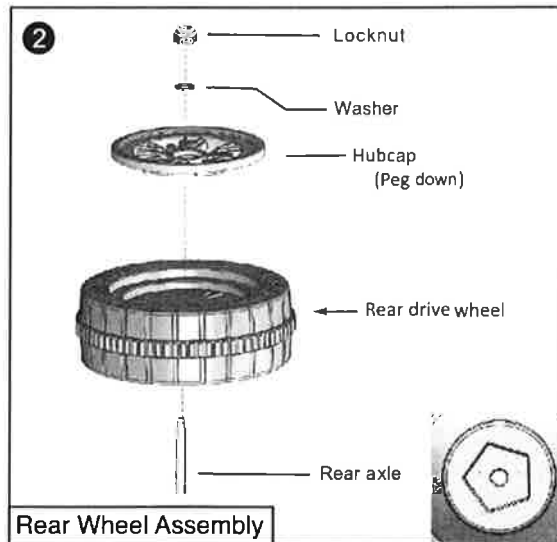

- Slide the hubcap, peg side down, onto the rear axle, followed by the washer and locknut.
Slide the rear drive wheel, ring side down, onto the rear axle.

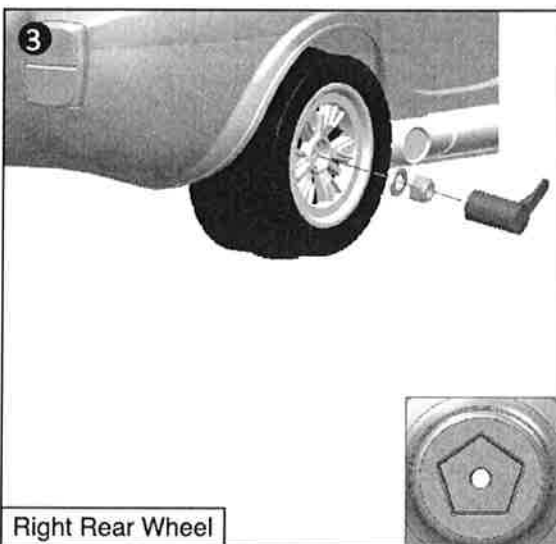

- Slightly tighten the locknut.

Assembly

10

Assembly III

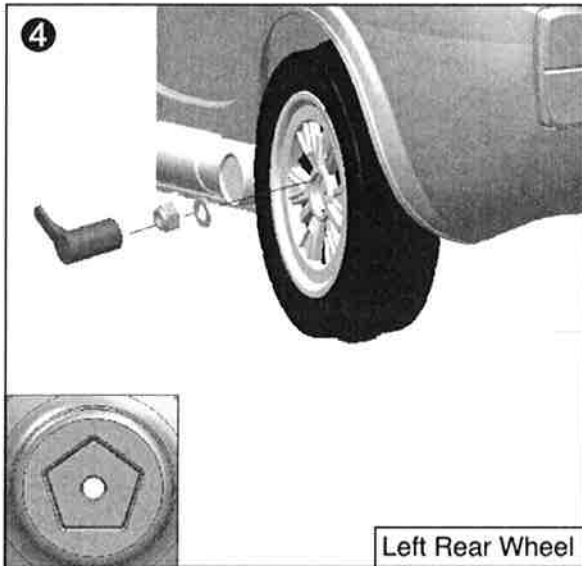

- Repeat for left rear wheel.

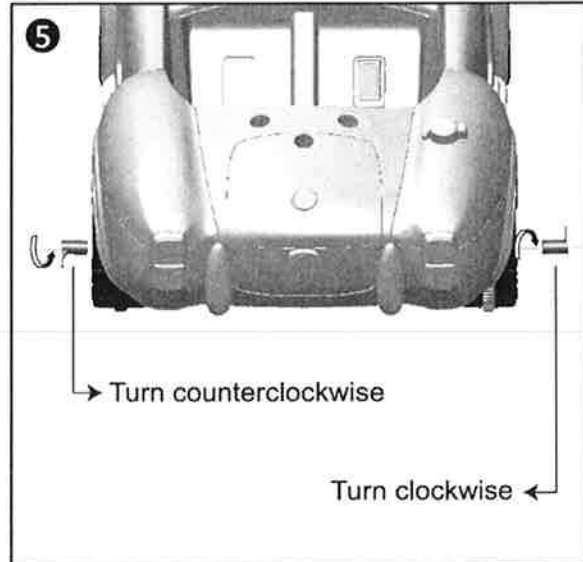

- Use locknut tools to tighten both rear wheels at the same time.

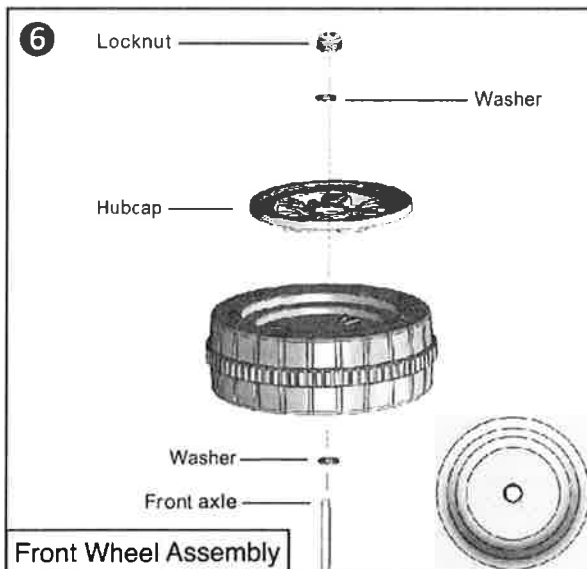

- Slide washer onto front axle as picture. Slide wheel and hubcap, followed by washer and locknut.

Assembly

11

Assembly III

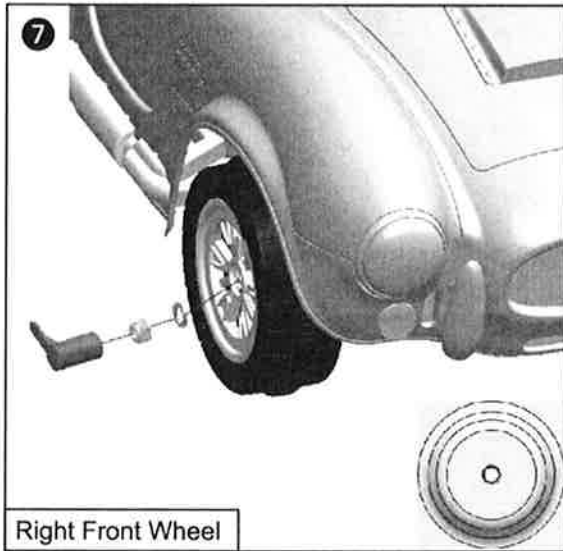

Right Front Wheel



Left Front Wheel

- Use the locknut tool to tighten the locknut.
- Repeat for left front wheel.



- Remove the bolt from the steering wheel.

Assembly

12

Assembly IV

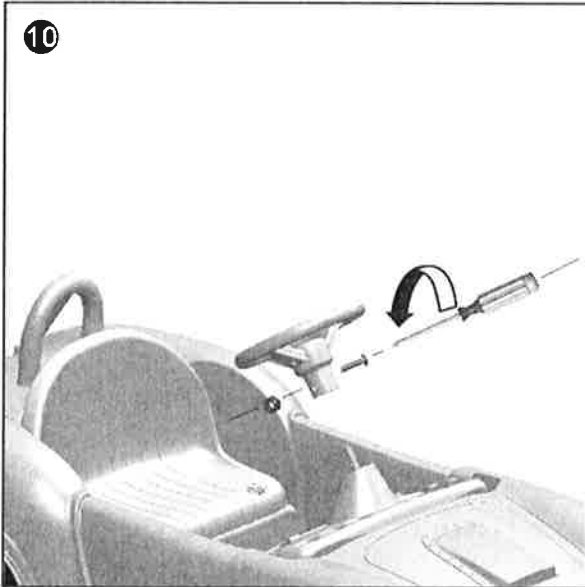

- 10 Place the steering wheel onto the steering column. Insert the bolt and tighten with a locknut.

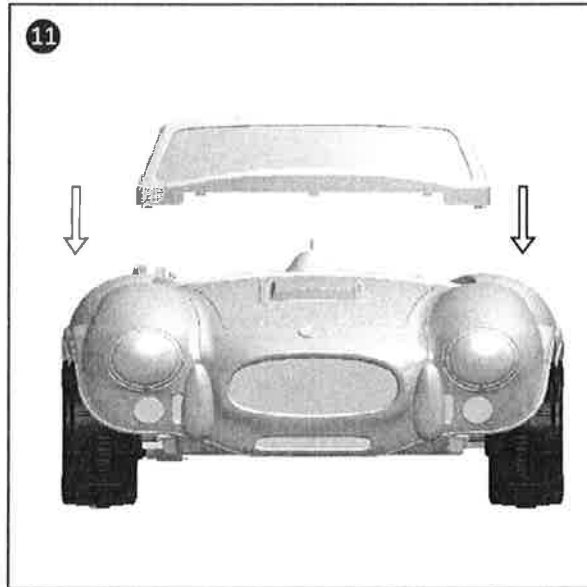

- 11 Fit the tabs of the windshield into the car body. Push until it "snaps" in place. Make sure it fits securely.

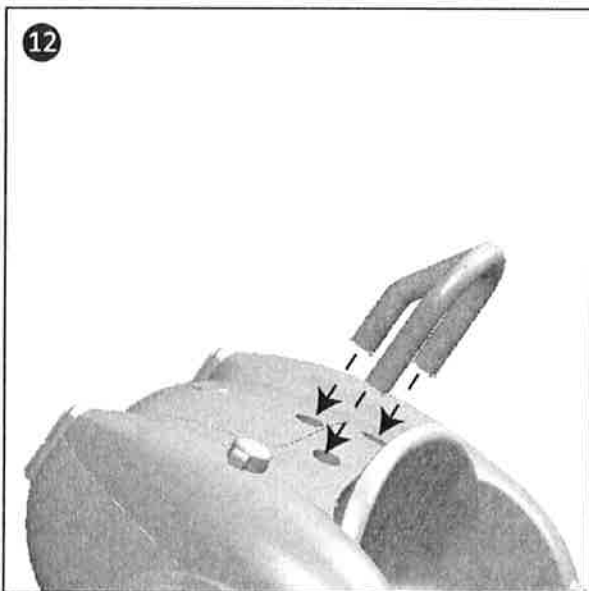

- 12 Insert the roll bar and push until it "snaps" in place.

Assembly

13

Assembly V

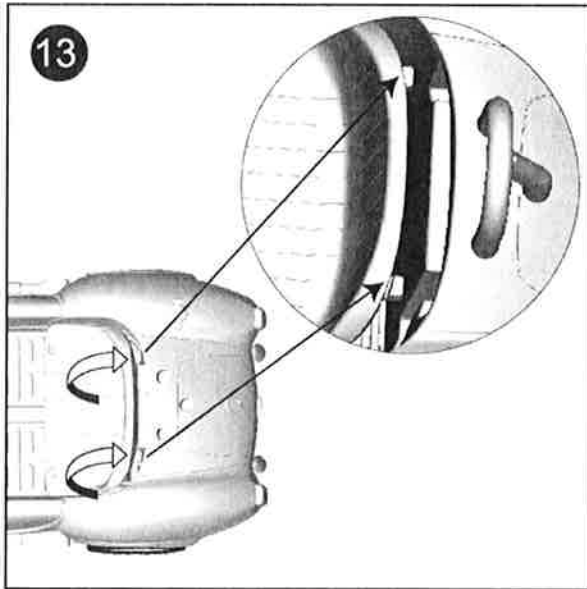

- Fit the tabs on the seat into the slots of the car body.

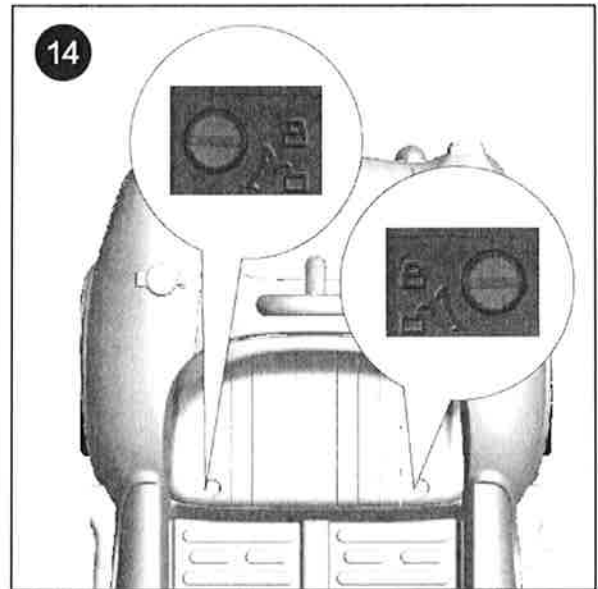

- To lock the seat, twist both screws from the vertical to the horizontal position.

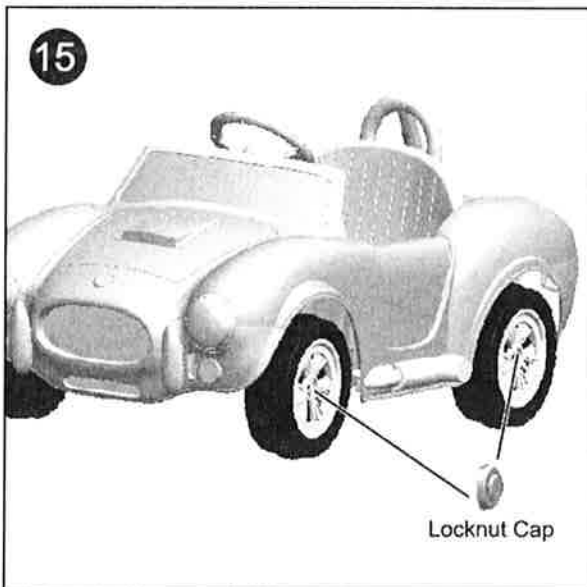

- Check and make sure that all screws are securely tightened.
Snap the locknut caps onto all wheels.

Operating Your Vehicle

Forward / Reverse

Place the switch in the 'forward' position to go forward. Place the switch in the 'reverse' position to go backward.

Low Speed

Place the switch in the down position to operate at low speed (2.5 mph, (4 kph) maximum).

High Speed

Place the switch in the up position to operate at high speed (5 mph, (8 kph) maximum).

Stopping

The vehicle will automatically stop after the accelerator is released.

Safety Devices

AUTO POWER OFF. If the motor is overloaded/overheated for any reason, an electrical circuit breaker will automatically shut off the power. You can resume play after the motor has cooled.

Maintenance

- Clean with a dry, soft cloth only. Do not wash with water or corrosive agents.
- Store vehicle in a dry area when not in use, since moisture could cause the metal components and electrical parts to corrode.
- Remember to charge the battery monthly while the vehicle is not in regular use.
- Check and tighten all screws and coverings regularly.
- Check all plastic parts for cracks. Replace as necessary.

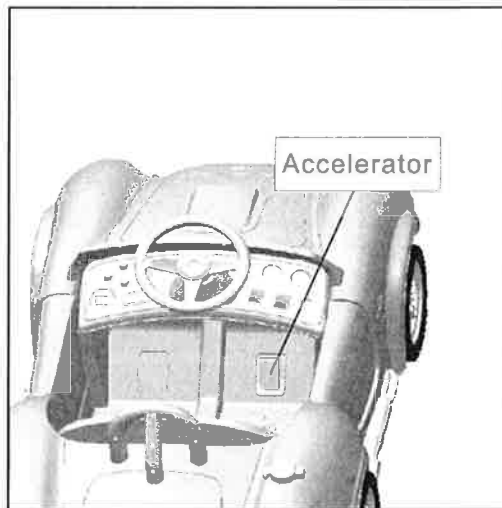
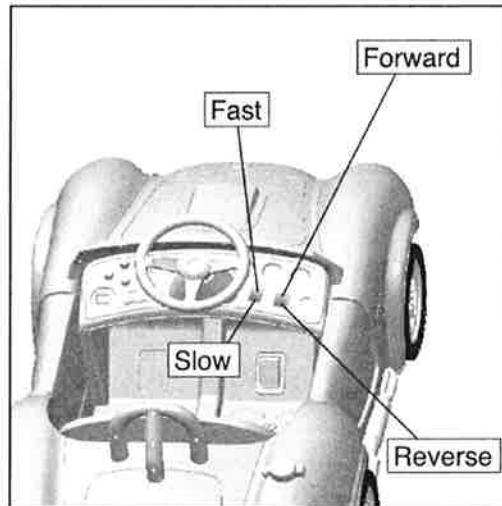

Troubleshooting

IMPORTANT! If you experience a problem with your vehicle, first check the Problems and Solutions Guide below. If you still experience a problem, please contact NPL[®] Service Center, at **1-909-594-4000 / 1-877-743-3899** (Toll-free) from 9 AM to 5 PM (PST) Monday through Friday. Or email us customerservice@funcreation.net or visit us www.funcreation.net for assistance and information from our trained technical staff.

15

Troubleshooting I

Problem	Possible Cause	Solution
Car does not move	Circuit breaker tripped	Circuit breaker may "trip" and stop the vehicle if it is overloaded or the driving conditions too severe. The breaker will automatically reset after approximately 10 seconds, and the vehicle will operate normally. To avoid repeated automatic shut downs, do not overload the vehicle by exceeding the weight limited of 66 lbs., Or by towing anything behind the vehicle. Do not drive up hills or run into fixed objects, which can cause the wheels to stop spinning while power is still being supplied to the motors. If breaker continually trips, contact your NPL [®] Service Center.
	Loose wire or connectors	Check all wires and connectors. Make sure that the motor harness connector is plugged in tightly to the battery, and that there are no loose wires around the motor.
	Dead battery	An old or improperly cared battery may be dead. If you are unsure whether it is dead or not, you can have it tested at your NPL [®] Service Center.
	Undercharged battery	A new battery should have been charged for at least 18 hours before using the vehicle for the first time. After that, it must be recharge the battery for at least 12 hours after each use. Never charge longer than 24 hours. Check all connectors; make sure the charger is plugged into the wall. Make sure the power flow to the outlet is on.
	Charger is not working	You must have a volt meter in order to tell whether the charger is working or not. If you think there maybe a problem with the charger , take it to the NPL [®] Service Center where they will test it for you.
	Electricity switch damages	When exposed to water or moisture, electricity can become corroded, or can jam due to loose dirt, sand or gravel. Contact your NPL [®] Service Center for diagnosis and repair.
Car was running but suddenly stopped	Loose wire or connectors	Check all wires and connectors. Make sure that the motor harness connector is plugged into the battery tightly, and that there are no loose wires around the motor.
	Circuit breaker tripped	Circuit breaker may "trip" and stop the vehicle if it is overloaded or the driving conditions too severe. The breaker will automatically reset after approximately 10 seconds, and the vehicle will operate normally. To avoid repeated automatic shutdowns, do not overload the vehicle by exceeding the weight limited of 66 lbs., or by towing anything behind the vehicle. Do not drive up hills or run into fixed objects, which can cause the wheels to stop spinning while power is still being supplied to the motors. If breaker continually trips, contact your NPL [®] Service Center.

Troubleshooting

Problem	Possible Cause	Solution
Short operating time (less than 1 hours per charge)	Undercharged battery	A new battery should have been charged for at least 18 hours before using the vehicle for the first time. After that, it must be recharge the battery for at least 12 hours after each use .Never charge longer than 24 hours. Check all connectors; make sure the charger is plugged into the wall. Make sure the power flow to the outlet is on.
	Overcharge battery	Never charge battery longer than 24 hours. If you think the battery maybe damage due to overcharging, contact NPL® Service Center for testing.
	Old battery will not accept a full charge	Even with proper care, a rechargeable battery does not last forever. Average battery life is 1 to 3 years depending on vehicle use and use conditions. Replace the battery with a new NPL® 12 volt rechargeable battery. Do not substitute parts. To get a replacement battery, please contact NPL® Service Center.
Vehicle is sluggish	Undercharged battery	A new battery should have been charged for at least 18 hours before using the vehicle for the first time. After that, it must be recharge the battery for at least 12 hours after each use. Never charge longer than 24 hours. Check all connectors; make sure the charger is plugged into the wall. Make sure the power flow to the outlet is on.
	Battery needs charging	Be sure to charge the battery after each use.
	Old battery will not accept a full charge	Even with proper care, a rechargeable battery does not last forever. Average battery life is 1 to 3 years depending on vehicle use and use conditions. Replace the battery with a new NPL® 12 volt rechargeable battery. Do not substitute parts. To get a replacement battery, please contact NPL® Service Center.
	Vehicle is overloaded	Allow no more than 1 rider at a time, follow the 66 lbs. (30 kg) weight capacity and don't tow anything behind the vehicle.
	Driving conditions are too stressful	Use only on a generally level ground.

Troubleshooting

17

Troubleshooting III

Problem	Possible Cause	Solution
Intermittent vehicle operation	Loose wire or connector	Check all wires around the motors and all connectors to make sure they are tight.
	Motor or electrical switch damage	Contact your NPL® Service Center for diagnosis and repair.
When the go foot pedal is pressed, the vehicle won't run without a push	Loose wire or connector	Check all wires around the motors and all connectors to make sure they are tight.
	"Dead Spot" on motor	Contact your NPL® Service Center for diagnosis and repair.
Motor gear box makes a loud grinding or clacking noise	Broken gears	Contact your NPL® Service Center for diagnosis and repair at 1-909-594-4000 / 1-877-743-3899.
Charger get warm during use	This is normal and should not be concern.	No action required.
Battery makes gurgling or sizzling noise while charging	Some noise and swelling is normal and should not be a concern	No action required. If the battery does not make noise while charging. It does not mean it isn't accepting the charging.

If, after reviewing the Problems and Solutions Guide, the vehicle still fails to operate, please contact your NPL®

Service Center at 1-909-594-4000 / 1-877-743-3899.

Note! For faster service when calling Consumer Relations, completely charge the battery before calling and have the following available by the phone:

Vehicle

Vehicle model number .

Vehicle production run number .

(The warranty and customer service contact in this manual only apply in the United States and Canada.)

Applying Decals

Proper label application will help to keep the labels looking their best! When applying labels, keep the following guidelines in mind:

- Wash your hands before applying the labels.
- Before applying the labels, wipe the surface of the vehicle with a clean, dry cloth to remove any dust or oils.
- Place the labels exactly as shown in the illustrations.
- For best results, avoid repositioning a label once it has been applied to the vehicle.
- After applying a label, rub the label firmly with a clean, dry cloth to make sure the label is adhered to your vehicle. Start at the center of a label, and smooth towards the outer edges to remove air bubbles.

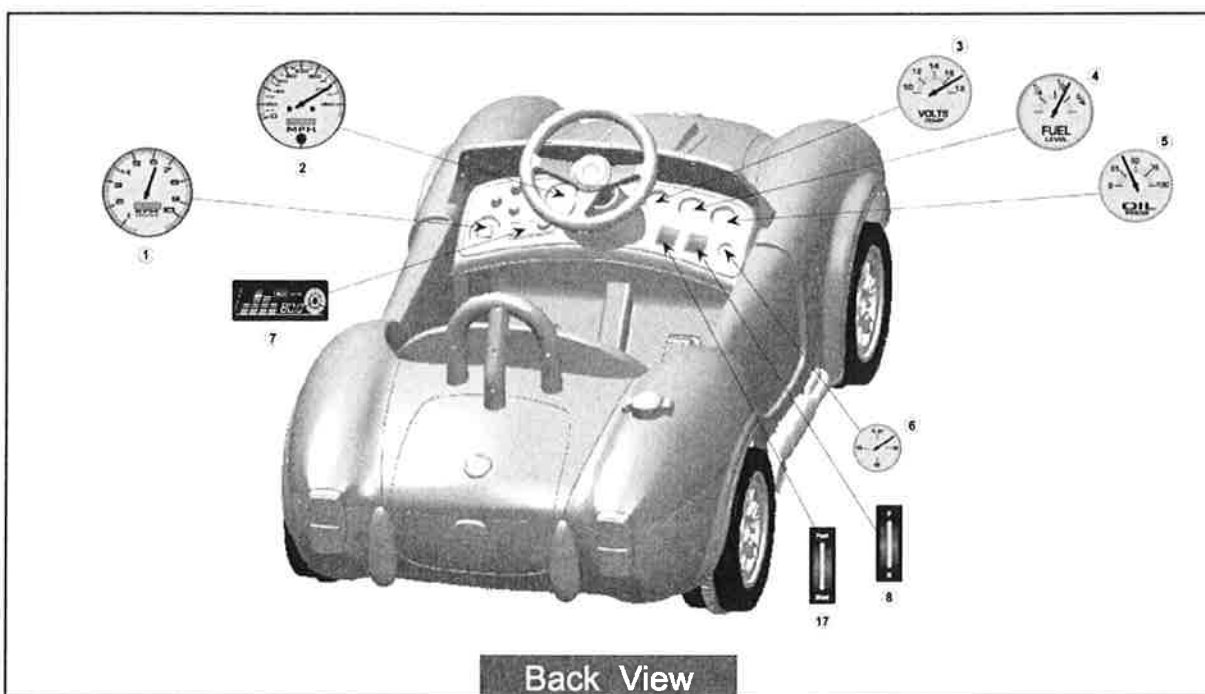
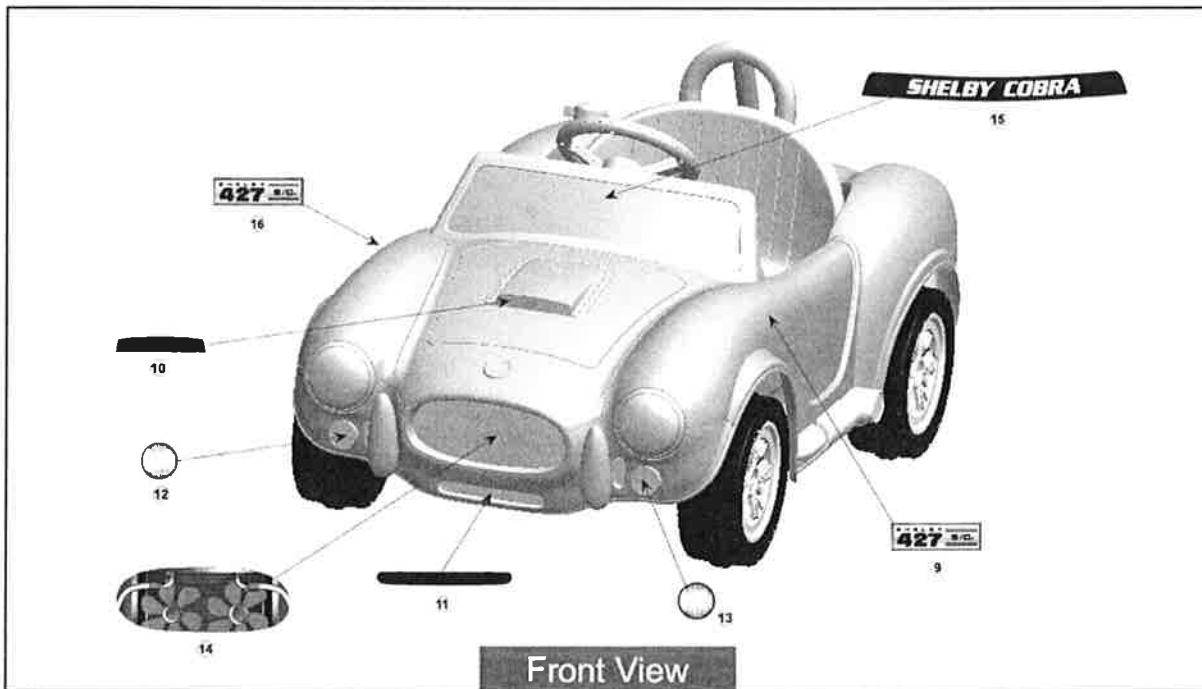

Parts Diagram

19

Parts Diagram

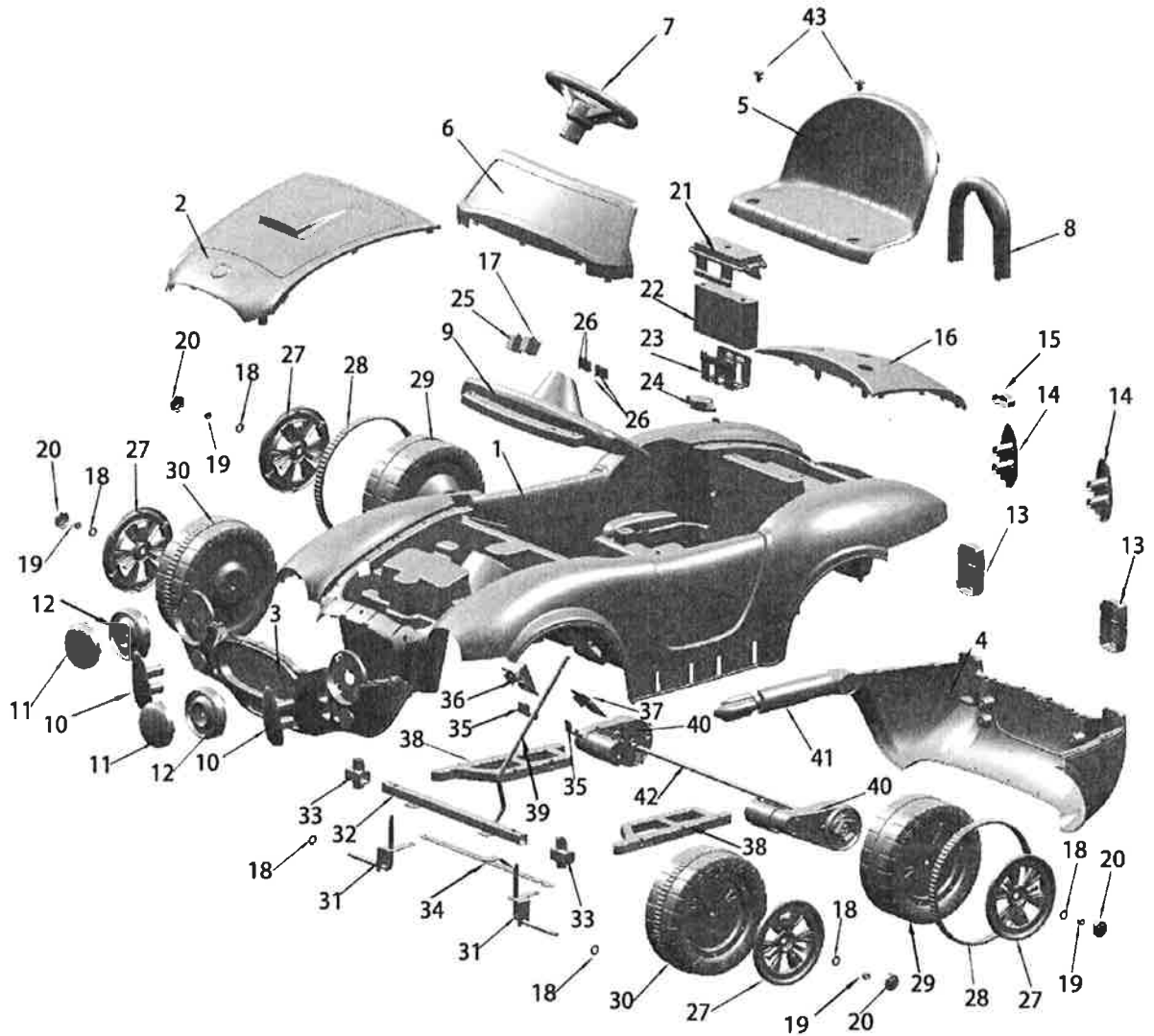

No. Part	Quantity	No. Part	Quantity	No. Part	Quantity
1. Car body	1	17. Fast and slow switch	1	33. Steering linkage holder	2
2. Hood	1	18. Washer	6	34. Steering linkage	1
3. Front grille	1	19. Large Locknut	4	35. Pedal wires fix	2
4. Rear bumper	1	20. Locknut cap	4	36. Pedal	1
5. Seat	1	21. Battery cover	1	37. Pedal cover	1
6. Windshield	1	22. Battery	1	38. Side support	2
7. Steering wheel	1	23. Battery base	1	39. Turning shaft	1
8. Roll bar	1	24. Oil tank cover	1	40. Gearbox	2
9. Dashboard	1	25. Forward and reverse switch	1	41. Exhaust pipe	2
10. Front bumper	2	26. Sound button	4	42. Rear axle	1
11. Head light cover	2	27. Wheel cover	4	43. Seat locknut	2
12. Head light	2	28. Wheel belt	2		
13. Tail light	2	29. Rear drive wheel	2		
14. Rear chrome parts	2	30. Front wheel	2		
15. Handle	1	31. Front axle	2		
16. Back cover	1	32. Front support	1		



National Products Limited

STOP!

DO NOT RETURN TO STORE

This product cannot be returned for a refund
after it has been unpacked and used.

Call our **1-909-594-4000**
1-877-743-3899

or fax us **1-909-869-5945** or
email us customerservice@funcreation.net
for assistance and information
from our trained technical staff.