

6V SUPERB QUAD

BATTERY OPERATED RIDE ON
FOR 3 AGES AND UP
MAXIMUM LOADING 25KGS (55LBS)
ITEM NO: 1511, 1512, 1513, 1514, 1515,
1516, 1517, 1518, 1519, 1520

WARNING:

To reduce the risk of injury, adult supervision is required. Never use in roadways, near cars, on or near steep inclines or steps, swimming pools or steps, swimming pools and other bodies of water. Always wear shoes, and never allow more than one rider.

USER'S MANUAL



IMPORTANT :
PLEASE READ THIS USER MANUAL BEFORE ASSEMBLY AND USE.

WARNING: ADULT ASSEMBLY REQUIRED!

CARE SHOULD BE TAKEN IN UNPACKING AND ASSEMBLY OF THE VEHICLE. CHILDREN SHOULD NOT HANDLE PARTS OR BATTERIES, OR HELP IN ASSEMBLY. CHILDREN CAN BE HARMED BY SMALL PARTS AND SHARP EDGES.



National Products Ltd.
Room 413-415, Houston Centre,
63 Mody Road, Tsim Sha Tsui East,
Kowloon, Hong Kong
WWW.NPL2.COM

Table of Contents

Important Information	2
Warning	3
Battery Charging	4
Parts List	5
Assembly	6-7
Vehicle Operating	8
Maintenance	9
Trouble Shooting	9
Limited Warranty	10

Important Information

- This product is intended for use by children ages 3 and up, and is not intended for children under 3 years of age due to lack of ability to operate safely.
- Maximum weight 25kg (55lbs). Only 1 rider at a time.
- You must charge your battery for 12 hours before you use your vehicle for the first time.
- Do not leave children unattended. Adult supervision required.
- This package contains small parts. Keep away from the children until assembled.
- Read this manual carefully for important safety information and operating instructions before using your vehicle. Keep these instructions for future reference as they contain important information.
- This vehicle is designed for use on: concrete, asphalt or other hard surfaces; on generally level terrain.
- Use this vehicle ONLY outdoors. Most interior flooring can be damaged by riding this vehicle indoors.
- NPL® will not be responsible for damage to the floor if the vehicle is used indoors.
- To prevent damaging the motors and gears, do not tow anything behind the vehicle or overload it. Do not exceed the maximum weight capacity of 25kg (55lbs).
- If you have any questions about your NPL® vehicle, please call our toll-free service lines at 1-877-743-3899 from 9 AM to 5 PM (PST) Monday through Friday.

Riding Warning

1. Do not leave children unattended. Adult supervision required.
2. This vehicle is not suitable for children under 3 years of age.
3. Never operate the car on or near roadways, streets, nearby moving vehicles, swimming pools, creek, sloped driveways, alleys, steps, sand, dirt or gravel.
4. Never drive in the dark. Unexpected obstacles could cause an accident.
5. Never drive in rainy or snowy conditions.
6. Never operate near flammable vapors (e.g. gasoline, paint thinner, acetone, etc.) Using the vehicle near flammable liquids can or vapors could cause an explosion or fire.
7. Always sit on the seat and wear shoes.
8. Do not place anything near moving parts such as motors, gears or wheels. Rotating parts can snag hair, fingers, etc., which may cause serious injury.

Warning Tips

Inspect the vehicle at regular intervals for wear or loose hardware. Tighten the parts as required. Remove from service if any abnormal conditions such as cracks or breaks exist.

- Check all coverings regularly to make sure they are in place. Always make sure the seat is securely attached.
- When the temperature falls below 0°F (-18°C), it is not recommended to use the product outdoors.
- In extreme cold, plastic materials might lose resilience and may become brittle and crack upon impact. Store the vehicle in a warmer and protected place.
- Disconnect the battery power supply when the vehicle is not in use to prevent the children driving the car without adult supervision.
- Only use the charger/battery specified by NPL.
- The charger and battery are not toys and must be regularly examined for damage to the cord, plug, enclosure and other parts.
- In the event of damage, the damaged or worn part must not be used until replaced.
- Never modify the electrical system. Use the wrong type battery or charger could cause a fire or explosion.
- Battery compartment and area under seat are not storage areas. Storing other articles may create a fire hazard.
- Do not store any articles in or near motor compartment.

Battery Charging

IMPORTANT

1. Battery charging must be done by an adult. Never allow your child to charge battery.
2. It is normal for the charger to become warm while the battery is charging.

Before first-time use, please follow these steps for battery charging:

1. To gain access to battery compartment, simply remove the screw at the back of saddle.

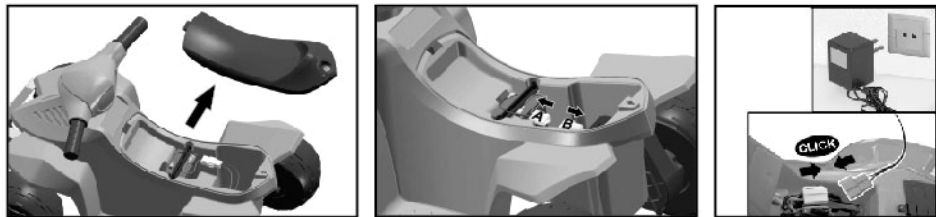











2. Before charging, make sure the volt and frequency of charger are in accordance with the outlet.
3. Charge the battery for 8-10 hours after each use. Never charge the battery longer than 24 hours.
4. After it is fully charged, battery plug must be connected back with the body plug.
5. Recharge the battery after each use, regardless of how long the vehicle was used. Do not allow the battery to run down completely.
6. Charge the battery for 8-10 hours once a month even if it is not being used.
7. Carry the battery by case. Do not carry the battery by the wires.
8. Supply terminals are not to be short-circuited.

Important Caution

1. Examine the charger and battery from time to time. If you find any damage, the battery and charger should not be used and must be replaced.
2. Battery life may be shortened if it is overcharged or undercharged.
3. Only battery and charger of the same or equivalent type are to be used.

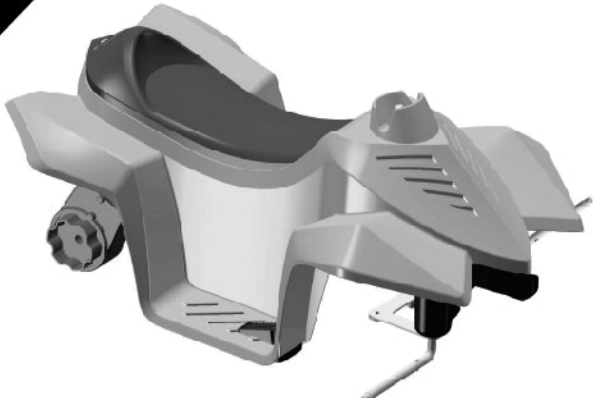
Parts List

- Please identify all parts before assembly and save all packaging material until assembly is completed to ensure that no parts are discarded.
- Metal parts have been coated with lubricant to protect them during shipment. Wipe all metal parts with a paper towel to remove any excess lubricant.

A  Front Bumper x 1	B  Axle x 1	C  Wheels x 4
D  Nut (M8) x 4	E  Self-Tapping Screw x 3	F  Nut (M5) x 1
G  Handlebar x 1	H  Main Body x 1	
I  Screw (M5) x 1		
J  Washer x 8	K  Charger x 1	L  Wrench x 2

Assembly



Children can be harmed by small parts, sharp edges and sharp points in the vehicles unassembled state, or by electrical items. Care should be taken in unpacking and assembling the vehicle. Children should not handle parts, including the battery, or help in the assembly of the vehicle.

1. FRONT BUMPER ASSEMBLING:

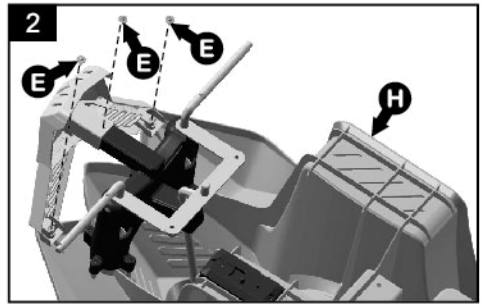
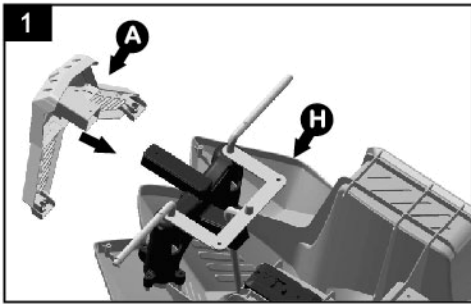

2. FRONT WHEELS ASSEMBLING:

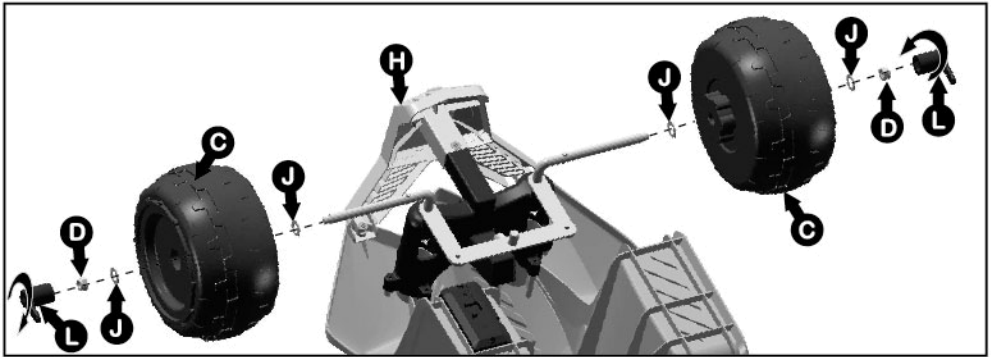

3. BACK WHEELS ASSEMBLING:

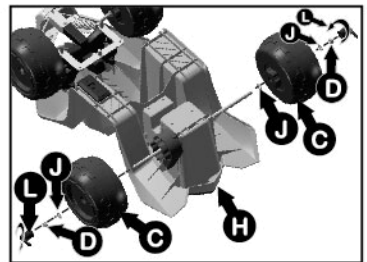
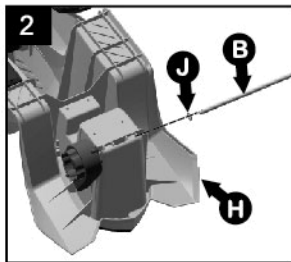
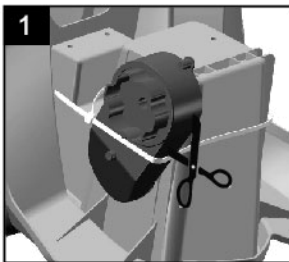

Assembly

4. HANDLEBAR ASSEMBLING:

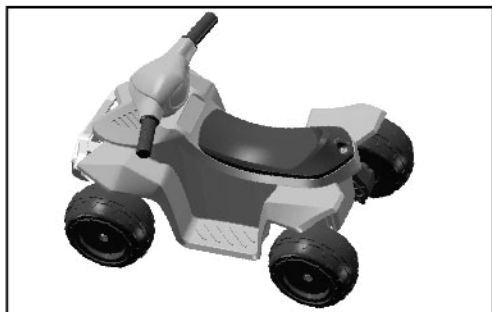
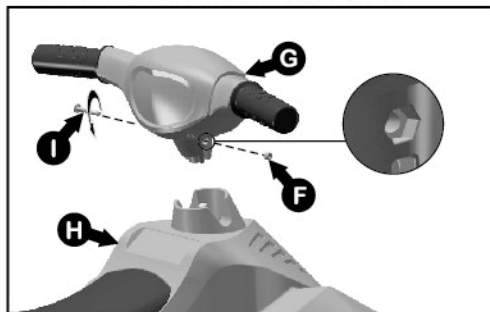

5. CONNECT THE SOCKET:

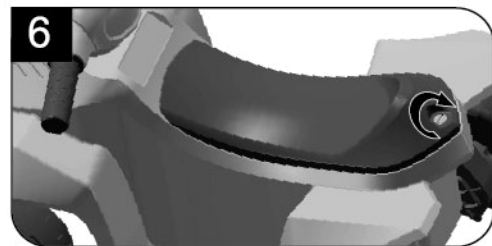
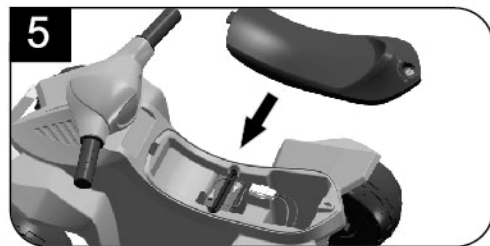
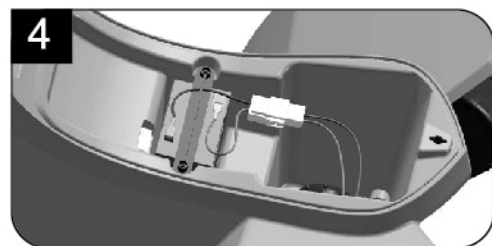
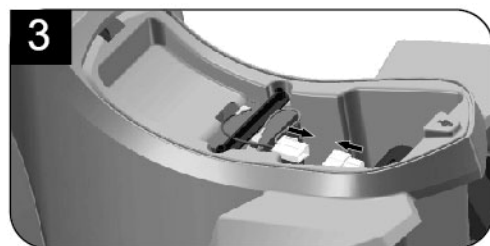
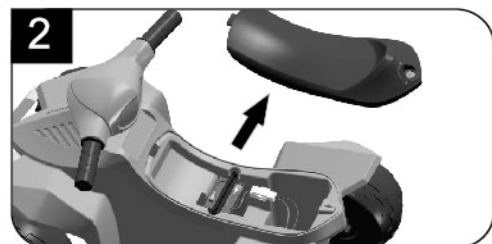
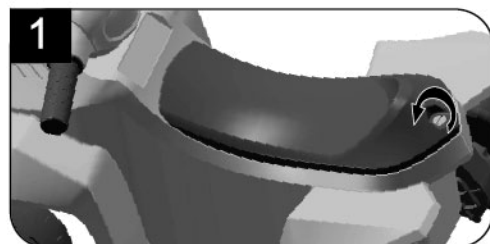

Vehicle Operating

1.How to drive the vehicle

Press an accelerator on the right pedal. The vehicle will stop after the pedal is released.

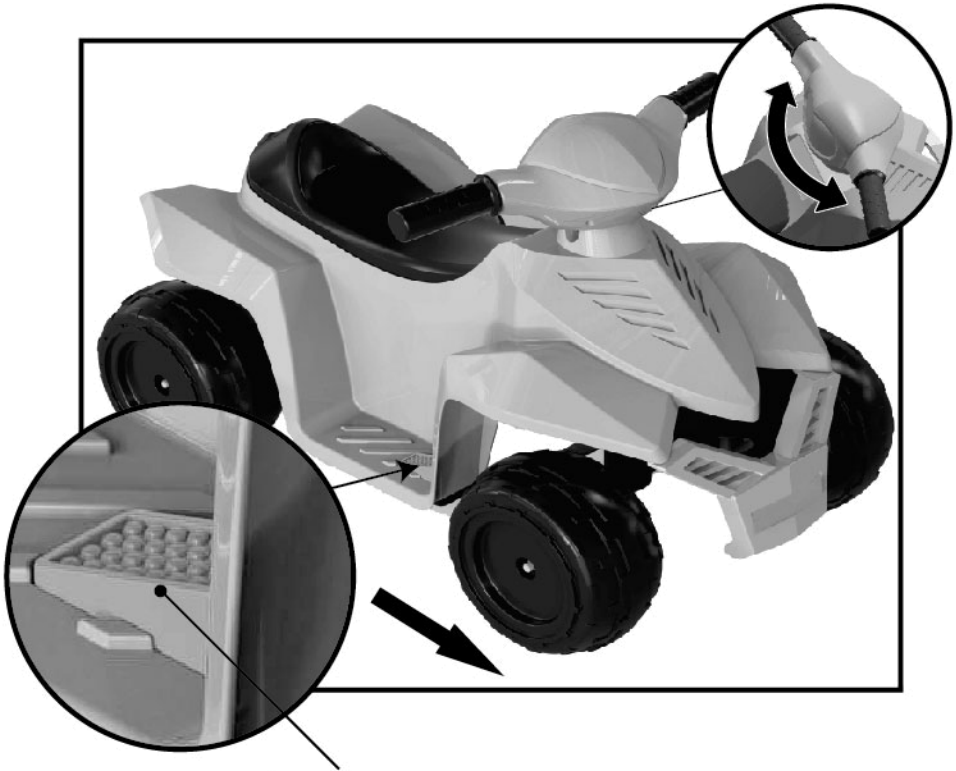

Accelerator

Caution:

Make sure the vehicle has come to a completely stop before switching between “forward” and “reverse”.

Maintenance

- 1.You should inspect the vehicle to make sure it is in good working condition.
- 2.Clean the vehicle with a soft and dry cloth.
- 3.Do not allow the buttons to get wet.
- 4.Store the vehicle indoors during rainy or snowing weather.

Trouble Shooting

Trouble	Possible problem	Solution
Vehicle does not run	Loose pedal	Press the foot pedal
	Loose wire or connectors	Reconnect
	Wheel was stuck	Remove the obstacle
	Undercharged battery	Recharge the battery
Vehicle is sluggish	Overloaded	Follow the standard weight
	Wheel was stuck	Remove the obstacle
	Undercharge battery	Recharge the battery
Battery cannot accept a full charge	Charger was loosen from outlet	Reconnect
	Broken charger	Replace a new one
	Broken battery	Replace a new one
	Old battery	Replace a new one



National Products Limited

STOP!

DO NOT RETURN TO STORE

This product cannot be returned for a refund after it has been unpacked and used.

We are here to help. For questions or service, call National Products Ltd. at **1-877-743-3899**

Limited Warranty

This vehicle is warranted by NPL[®] for ninety days from date of purchase against defects in materials or workmanship. During the warranty period, NPL[®] will repair or, at its discretion, replace any defective vehicle provided that the vehicle has been used under normal circumstances, solely for the purpose for which it was intended and has been given proper care and maintenance. This warranty does not cover damage by customer, damage which results from normal wear and tear or from alterations made by the customer, or damage caused by use for an unintended purpose. NPL[®] shall be liable under this warranty only for repair or replacement of the ride-on unit. Warranty does not cover shipping & handling. For HELP, call our Customer Service Department at 1-(877)743-3899 or contact us via email at customerservice@funcreation.net.

Caution: The warranty and customer service contact in this manual only apply in the United States and Canada. If the vehicle is sold as a display unit, it shall not be covered by this warranty, and no repair or replacement of any defective and missing parts will be offered.

Call our toll-free **1-877-743-3899** or fax us **1-909-869-5945** or e-mail us **customerservice@funcreation.net** or visit us **www.funcreation.net** for assistance and information from our trained technical staff.