



P.O. Box 519	1351 W. Second Street	379 Davis Road, Unit #3
Corona, California 92878-0519	Oconomowoc, Wisconsin 53066	Oakville, Ontario, Canada L6J 2X2
Phone: 909-735-8220; 800-543-3885; 800-735-1922	Phone: 262-567-2288	Phone: 905-844-1791; 800-361-9473
Fax: 909-735-2372; 800-752-6001; 800-735-0857	Fax: 262-567-0857	Fax: 905-844-2533; 800-663-0933

HD-500-3 INSTRUCTIONS FOR INSTALLATION

PLEASE READ CAREFULLY BEFORE STARTING INSTALLATION

CAUTION

MAKE CERTAIN POWER SUPPLY IS DISCONNECTED BEFORE INSTALLING, REPAIRING, OR WORKING IN THE PROXIMITY OF ANY ELECTRICAL SYSTEM. ONLY QUALIFIED ELECTRICAL PERSONNEL SHOULD INSTALL OR REPAIR THESE PRODUCTS.

PRELIMINARY

Check all materials to be sure that the proper number of brackets, hanger clamp assemblies, bolted joint assemblies, joint covers, power feeds, end caps, collectors, expansion gap assemblies, (when needed) isolating sections, (when needed) anchor clamp sets, and proper quantity of conductor bar assemblies have been received.

SPRAY PAINTING

Spray painting should be done prior to the installation of the Duct-O-Bar runway. If spray painting is done after installation extreme care should be taken to protect the contact surface of the conductors with the use of masking materials. Paint on these surfaces will cause serious operational difficulties.

SYSTEM LAYOUT

For systems under 300 ft. in runway length there are usually no expansion gap assemblies required and you may skip the instructions for that step. For those systems that are longer IT IS IMPORTANT THAT THE HANGER BRACKET INSTRUCTIONS ARE FOLLOWED CLOSELY.

Using the following schematic diagram as a guide, make a simple system drawing and mark the appropriate locations of the brackets, power feeds, and expansions gap assemblies (when used) and the anchor locations. Now you are ready to start.



Approved

File No. LR 24077-39

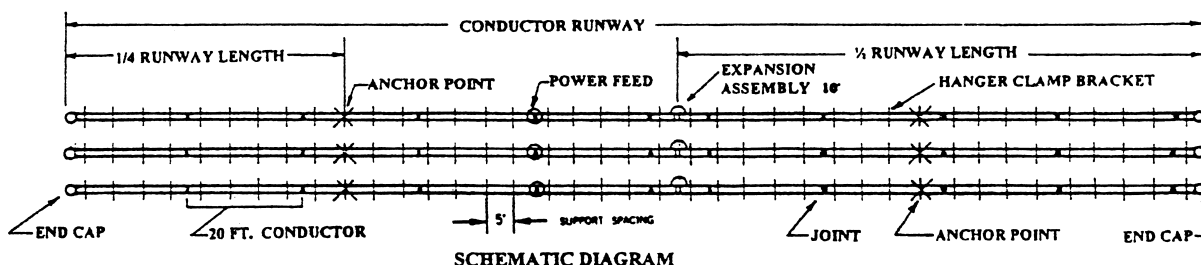

STEP 1. HANGER CLAMP BRACKET INSTALLATION

Starting at one end of the runway, place a mark for the first bracket at least 9 inches in from the end. Sight in the remaining brackets every 5 feet after the first one except when expansion gap assemblies are used. At the point where an expansion gap is used it will be necessary to check the expansion gap assembly so that the bracket will align with the mounting bolt location on the transfer guide above the gap location. See STEP 4 on page 2.

STEP 2. HANGER CLAMP INSTALLATION

Fasten the hanger clamps to the brackets, leaving the nuts finger tight. When the hanger clamps are in place the conductor bar can be installed. See STEP 3.



FE-908-2SF

Hanger



FE-908-2SFG

Hanger w/Insulator

STEP 3. CONDUCTOR BAR INSTALLATION

Before raising the conductors to the hangers, it may be desirable to fasten the bolted joint into the trailing end of the conductor assembly. See BOLTED JOINT CONNECTIONS in Step 6 for joint compound application. Next, raise the section to be installed up to the bracket location and snap the conductor into the hanger clamps as shown in the illustration below. Hanger clamps should be at least 9 inches from the joints or power feeds to allow room for their covers.

Mounting Bolt
(Leave Loose)

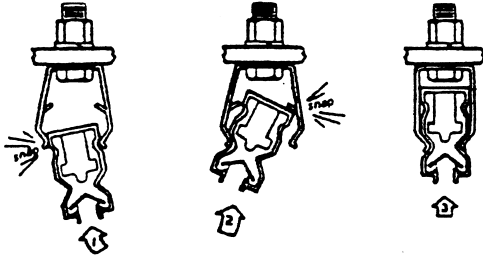
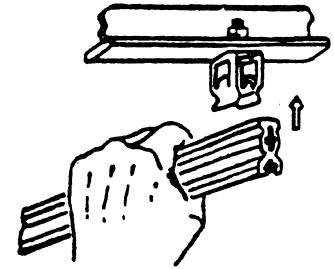

NOTE: The center mounting bolt is the location for a bracket support for the expansion gap assembly. Whenever the System uses hangers with insulators there must be an insulator on the mounting bolt.

STEP 4. EXPANSION GAP ASSEMBLY

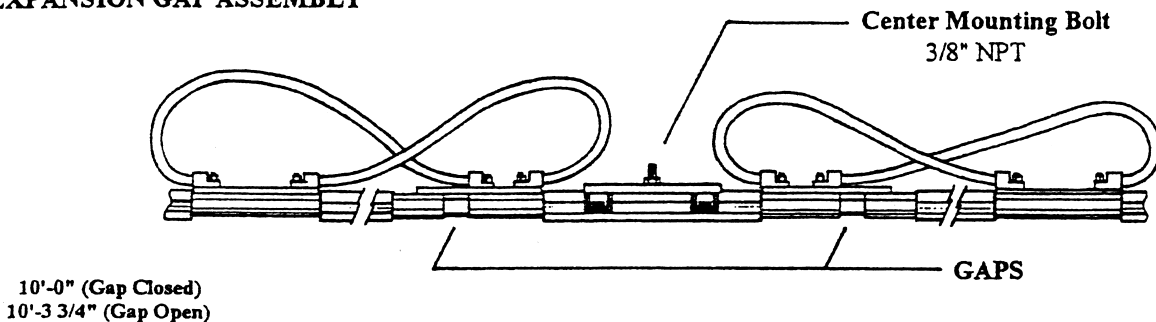

Expansion sections should be placed at intervals determined by the ambient temperature rise at the conductor location and the length of the runway. For a runway length of 250 to 300 ft. in length, the first expansion assembly should be placed in the center of the runway. For long runways, an expansion assembly should be placed approximately every 250 to 300 ft.

There are two gaps in each assembly. Each gap will open to a maximum of 1.75 inches, so the maximum gap opening for each assembly is 3.5 inches. **SET THE GAPS AS FOLLOWS:**

1. Given an operating temperature range at the conductor of 60 F. which would be from 50 F. in Winter to 110 F. in Summer in an enclosed area.
2. At installation the ambient temperature measured 65 F. Since the gaps are wide open at the coldest (50 F.) temperature, the gap should be set at a fraction determined by the position of the ambient temperature at installation in relation to the operating span. $110 - 65 = 45 / 60 = 3/4$ of the max. opening of 3.5" or 2.6" Open each of the two gaps 1.3 inches.

ANCHORS: There must be one or more anchor points in a properly installed conductor system. For a system with no expansion gaps, install a single anchor in the center of each conductor run. With one expansion gap, an anchor is placed halfway between the gap and each end of the system. There is a separate anchor installation detail.

RATE OF THERMAL EXPANSION

in./100 ft./100 F. change-	1.56"
in./100 ft./50 C. change-	1.40"
cm./100 m./50 C. change-	11.7 cm.

STEP 5. HANGER CLAMP ADJUSTMENT

After aligning the conductor bar in the hanger clamps, the hanger clamp mounting bolts may be tightened. Tighten only until the lock washer is flattened. Be sure that the hanger clamps are straight before going on.

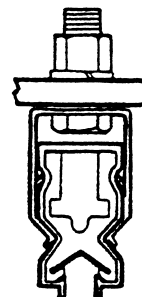

Mounting Bolt
3/8" NPT

STEP 6. BOLTED JOINT CONNECTIONS

Before joining the conductor bars, the top surfaces of the bars and adjoining surfaces of the joints must be wire brushed to remove any oxide that has formed on the aluminum. After brushing the surfaces, apply electrical joint compound to the newly cleaned areas.

STEP 7. POWER FEED INSTALLATION

At the predetermined location, install a power feed assembly in lieu of a bolted joint. Use the same procedure as the bolted joint but, in addition, apply electrical joint compound between the wire terminals and the power feed bar. Then install the power feed cover. Note the location for the electrician.

Each power feed lug holds up to a 1/0 cable. For maximum capacity use two 1/0 cables per power feed from the power circuit conduit.

The cover for the HD-500-3CP power feed is similar to the joint cover. After placing the two halves together, install the spring clips.

STEP 8. END CAP INSTALLATION

On both ends of each conductor run it is necessary to install an insulated end cap. CUT THE EXPOSED END of the conductor bar back to the insulated cover. Then install the black plastic end cap over the conductor cover until it fits firmly against the end of the conductor.

The HD-500-3ER joint cover is a two piece unit with 3 spring clips. After joining the two halves, install the 3 spring clips.

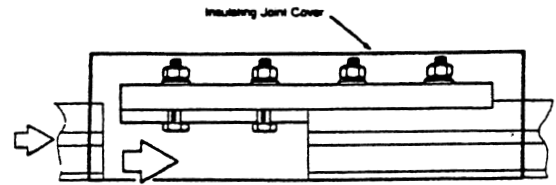
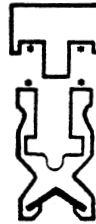

If you have already fastened one end to the conductor bar, it is only necessary to slide the joint into the adjoining conductor. It may be necessary to position the bolt heads to make it easier to slide them into the slot. Tighten the bolts firmly after making sure that the conductors are butted up tight to each other. Then, install the joint cover.

SYSTEM PARAMETERS	500 AMP SYSTEM
Continuous Current Rating (Amps)	500
Weight of Conductor (lbs./ft.) — (Aluminum and Stainless Cap)	.470
D. C. Resistance (ohms/ft.)	.000056
AC Impedance (ohms/ft.) @ 3 Inch Spacing	.00007

VOLTAGE DROP CALCULATIONS — 3 PHASE SYSTEM

$$V = 1.73 \times I \times L \times Z$$

where V = voltage drop (volts)

I = load current (amperes)

L = length of conductor run from feed-in point

Z = AC impedance of conductor

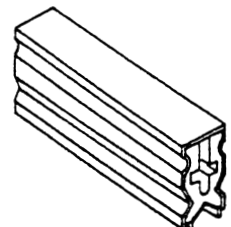
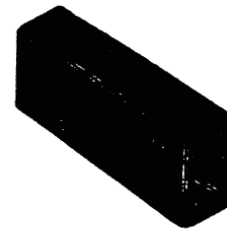
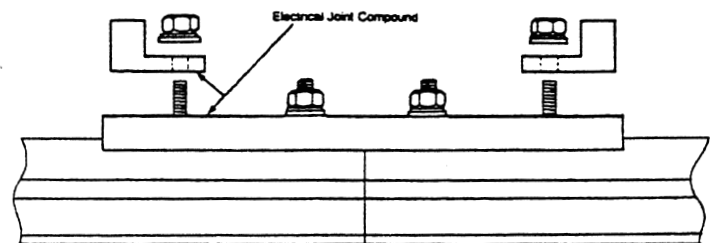

HD-500-3GC
FLEXIBLE END CAP

STEP 9. COLLECTOR INSTALLATION

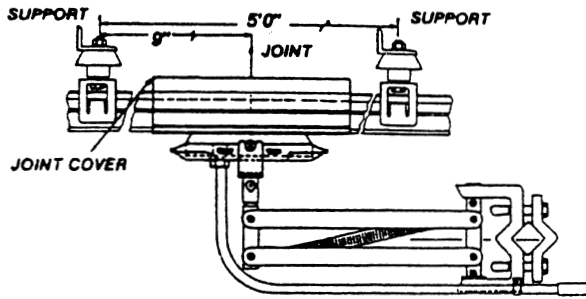

Align collectors directly under each conductor. Be sure that the spacing from centerline of the tow arm to the surface of the conductor is 4 inches or that the arms of the collector are parallel to the conductor.

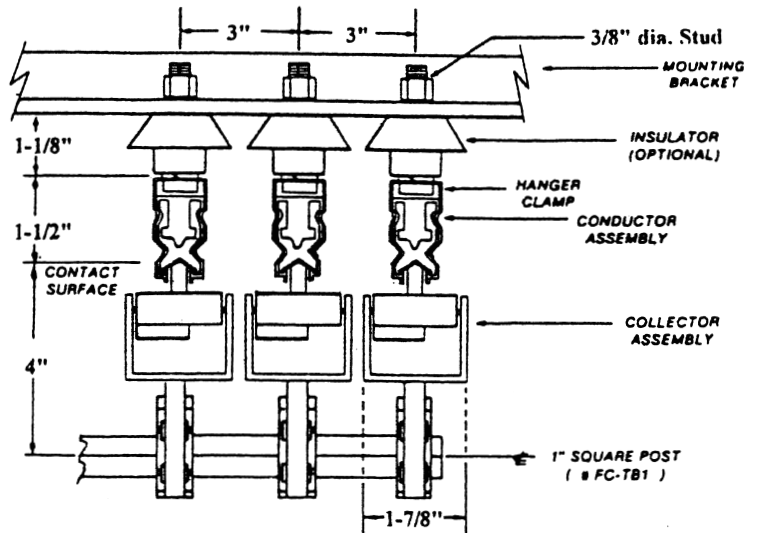

Typical System Installation

INSTALLATION DIMENSIONS - COLLECTORS

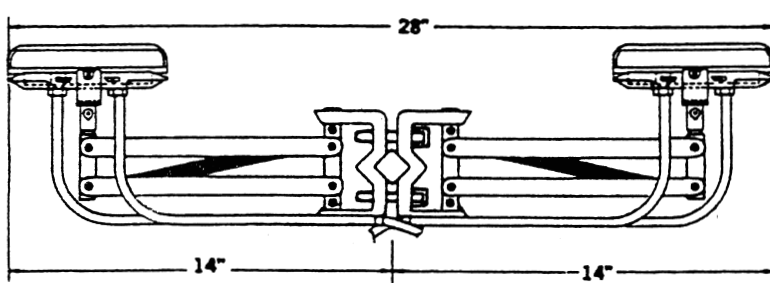

PANTOGRAPH TANDEM COLLECTOR - HDP-500-VT6 SHOWN

HDP-300-VT5
HDP-300-VT5-BR

HDP-500-VT6
HDP-500-VT6-BR

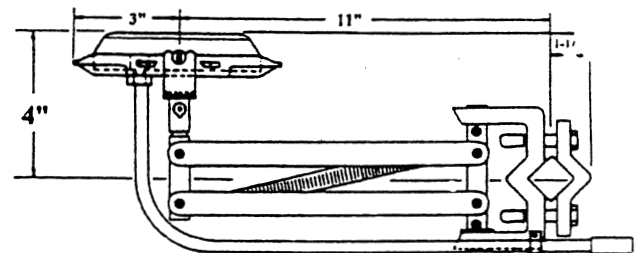

PANTOGRAPH SINGLE SHOE COLLECTOR

HDP-150-V5 SHOWN

HDP-150-V5
HDP-150-V5-BR
HDP-250-V6
HDP-250-V6-BR

STEP 10. FINAL INSPECTION

After all installation work is complete, sight down the installed conductors and straighten any chance bends or misalignment. Check the expansion gap openings (if used) to make certain that gap openings are still set as calculated. Check to make sure that all joint covers, power feed covers, and end caps have been properly installed.

After checking all connections, turn ON the power to the system. Run the unit and check that the collector shoes pass freely through the conductor cover, joint covers, power feed covers, and expansion gap assemblies when used.

FIELD CUT

Duct-O-Wire recommends that all conductor bar electrification be field cut immediately beyond required collector travel or a maximum of 9" past the last support bracket. Be sure that conductor bars are clear of any other electrical power lines by at least 9 inches. **KEEP ALL CONDUCTOR POWER OFF DURING CONSTRUCTION.**